

Duct Temperature/Humidity Sensor

Duct Temperature Sensor

Duct Humidity Sensor

General

Duct temperature/humidity sensor Model HTY78X3 series uses a platinum resistance temperature detector for a temperature sensing element, and a polymer capacitive humidity sensor (FP3™ developed by Azbil Corporation) for a humidity sensing element, enhancing accuracy and reliability of temperature/humidity sensing.

With wide sensing range and great stability, Model HTY78X3 series is suitable for various applications including building air conditioning (ducts and AHU) and meteorological observation as well as industrial applications.

Model TY78X3 series temperature sensor and Model HY78X3 series humidity sensor are also available.

AHU: Air handling unit

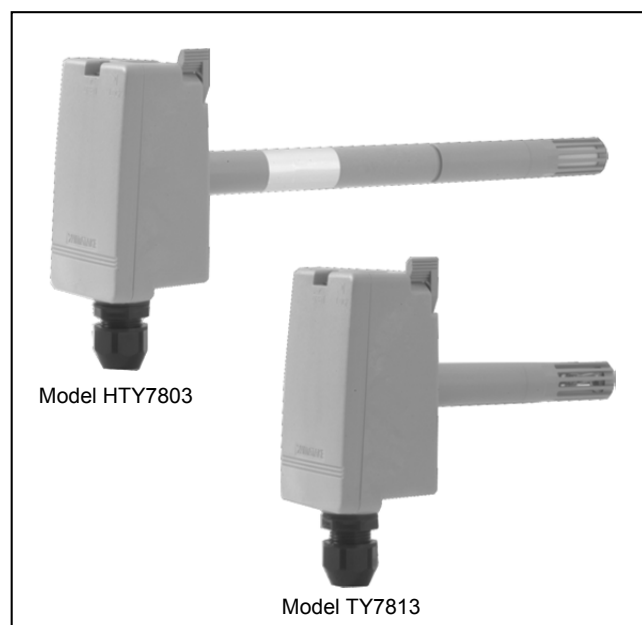

Features

- Wide temperature/humidity sensing range with high accuracy.
- Excellent long-term stability.
- Highly environmental resistance.
- Quick response and high repeatability.
- Easy installation to a duct/AHU with quick-detachable bracket (dedicated).
- Dust-proof and splash-proof housing (IEC IP54).
- No filter maintenance required:
Filterless probe of Model TY78X3Z series is the splash-proof enclosure.
- CE Marking certified product:
The following models conform to all the applicable standards of CE Marking.
 - Model HTY78X3 series
 - Model HY78X3 series



Safety Instructions

Please read instructions carefully and use the product as specified in this manual. Be sure to keep this manual near by for ready reference.



Usage Restrictions



This product is targeted for general air conditioning. Do not use this product in a situation where human life may be affected. If this product is used in a clean room or a place where reliability or control accuracy is particularly required, please contact our sales representative. Azbil Corporation will not bear any responsibility for the results produced by the operators.











Warnings and Cautions

	WARNING	Alerts users that improper handling may cause death or serious injury.
	CAUTION	Alerts users that improper handling may cause minor injury or material loss.

Signs





	Alerts users possible hazardous conditions caused by erroneous operation or erroneous use. The symbol inside \triangle indicates the specific type of danger. (For example, the sign on the left warns of the risk of electric shock.)
	Notifies users that specific actions are prohibited to prevent possible danger. The symbol inside \odot graphically indicates the prohibited action. (For example, the sign on the left notifies that disassembly is prohibited.)
	Instructs users to carry out a specific obligatory action to prevent possible danger. The symbol inside \bullet graphically indicates the actual action to be carried out. (For example, the sign on the left indicates general instructions.)

 WARNING	
	Before wiring and maintenance, be sure to turn off the power to the product. Failure to do so might cause electric shock.
	After wiring, be sure to reattach the terminal cover. Failure to do so might cause electric shock.

 CAUTION (1/2)	
	Install the product in a location that satisfies the operating conditions (temperature, humidity, power, vibration, shock, mounting direction, atmospheric condition, etc.) as listed in the specifications and use the product within the operating ranges as listed in the specifications. Failure to do so might cause fire or device failure.
	Take anti-lightening measures based on regional and building characteristics. Lightening might cause fire or critical damage to the products without the anti-lightening measures.
	Installation and wiring must be performed by qualified personnel in accordance with all applicable safety standards.
	All wiring must comply with applicable codes and ordinances.
	Be sure to provide a circuit breaker for the power to the product.
	To connect the wires to the screw terminals, use crimp terminal lugs with insulation. Failure to do so might cause fire or device failure due to short circuit.
	Firmly tighten the terminal screws. Insufficient tightening of the terminal screws might cause fire or overheating.
	Do not use unused/spare terminals on the product as relay terminals. Doing so might cause malfunction.
	If more than the rated power voltage is applied to the product, replace the product with new one for your safety. Failure to do so might cause device failure or overheating.

 CAUTION

(2/2)

- | | |
|---|--|
|  | Do not use transceivers or low power wireless devices near this product.
Doing so might cause radio wave interference and malfunction of the product. |
|  | Carefully press the rubber packing.
Your fingers holding the tool might slip causing injury if you put too heavy force on the rubber packing. |
|  | Do not disassemble the product.
Doing so might cause device failure. |
|  | Dispose of this product as industrial waste in accordance with your local regulations. Do not reuse all or a part of this product. |

IMPORTANT:

- Measuring accuracy of the product is preset before shipment. Output of the product, used even in normal air, may be shifted depending on the operating conditions. Periodic inspection therefore is recommended.
- Corrosive gas or organic solvent may cause shift in output or damage the product. Before using the product in abnormal atmosphere, consult with our salesperson.

Model Numbers

Base model number	Type	—	Power supply	Humidity output	Temperature output	—	Description
HTY78							Duct temperature/humidity sensor
TY78							Duct temperature sensor
HY78							Duct humidity sensor
	0						Long probe
	1						Short probe
		3					Fixed.
			T				24 V DC / 24 V AC
			Z				No power required
			D				24 V DC (two-wire)
				0			No humidity sensing
				1			1 V DC to 5 V DC
				4			4 mA DC to 20 mA DC
					0		No temperature sensing
					4		4 mA DC to 20 mA DC
					P		RTD (Pt100)
					K		RTD (Pt1000)
						00	Fixed.

RTD: Resistance temperature detector

Regarding the available model numbers, refer to the table below.

Available model numbers

Model number	Type	Power	Humidity output	Temperature output
HTY7803T1P00	Long probe	24 V DC/AC	1–5 V DC	RTD (Pt100)
HTY7813T1P00	Short probe			
HY7803T1000	Long probe	24 V DC/AC	1–5 V DC	N/A
HY7813T1000	Short probe			
HTY7803T4P00	Long probe	24 V DC/AC	4–20 mA DC	RTD (Pt100)
HTY7813T4P00	Short probe			
HY7803T4000	Long probe	24 V DC/AC	4–20 mA DC	N/A
HY7813T4000	Short probe			
TY7803Z0P00	Long probe	No power	N/A	RTD (Pt100)
TY7813Z0P00	Short probe			
TY7803Z0K00	Long probe	No power	N/A	RTD (Pt1000)
TY7813Z0K00	Short probe			
HTY7803D4400	Long probe	24 V DC (two-wire)	4–20 mA DC	4–20 mA DC
HTY7813D4400	Short probe			
HY7803D4000	Long probe	24 V DC (two-wire)	4–20 mA DC	N/A
HY7813D4000	Short probe			
TY7803D0400	Long probe	24 V DC (two-wire)	4–20 mA DC	4–20 mA DC
TY7813D0400	Short probe			

Optional parts

Part number	Description
83157235-001	Mounting bracket with packing, indicator label for installation hole, M4 screws
83157240-004	Conduit mounting set (for Models HTY78X3D, HY78X3D, TY78X3D series) for cable with \varnothing 11 mm to \varnothing 14 mm outer diameter
83157240-009	Conduit mounting set (for Model TY78X3Z series) for cable with \varnothing 9.4 mm to \varnothing 11 mm outer diameter
83104098-004	Seal connector (for Models HTY78X3D, HY78X3D, TY78X3D series) for cable with \varnothing 10.5 mm to \varnothing 14.5 mm outer diameter
83104098-003	Seal connector (for Model TY78X3Z series) for cable with \varnothing 8.5 mm to \varnothing 12.5 mm outer diameter
DY8000A1001	Sensor shield for installing outdoors
DY3002A1005	Mounting bracket for installing in a instrument shelter (L-shape bracket)

Service parts

Part number	Description
83162945-003	Filter set (filter and filter cap)

Specifications

(1/2)

Item		Specification		
Measuring range	Temperature	-20 °C to 60 °C		
	Humidity	0 to 100 %RH (non-condensing)		
Measuring accuracy	Temperature	RTD (Pt100)	±0.3 °C (at -20 °C to 60 °C) * 1 mA applied current, 2 m/s air velocity for Models HTY78X3TXP00, TY78X3Z0P00	
		RTD (Pt1000)	±0.5 °C (at -20 °C to 60 °C) * 0.1–0.3 mA applied current, 2 m/s air velocity for Model TY78X3Z0K00	
		4–20 mA DC	±0.5 °C (at 0 °C to 50 °C) / ±0.3 °C (at 15 °C to 35 °C) for Models HTY78X3D series, TY78X3D series	
	Humidity	±3 %RH (within 30 %RH to 70 %RH range, at 25 °C) ±5 %RH (within 20 %RH to 80 %RH range, at 15 °C to 35 °C)		
Output signal	Temperature	100 Ω / 0 °C (RTD (Pt100) conforming to JIS C 1604 Class A) for Models HTY78X3TXP00, TY78X3Z0P00		
		1000 Ω / 0 °C (RTD (Pt1000) equivalent to JIS C 1604 Class A) for Model TY78X3Z0K00		
		4 mA to 20 mA DC (two-wire, liner to -20 °C to 60 °C) * Maximum allowable load: 500 Ω for Models HTY78X3D series, TY78X3D series		
	Humidity	1 V DC to 5 V DC (linear to 0 %RH to 100 %RH) * Input impedance of the controller connected: Min. 10 kΩ for Models HTY78X3T1P00, H78X3T1000		
4 mA DC to 20 mA DC (linear to 0 %RH to 100 %RH) * Maximum allowable load: 300 Ω for Models HTY78X3T4P00, HY78X3T4000				
4 mA DC to 20 mA DC, two-wire (linear to 0 %RH to 100 %RH) * Maximum allowable load: 500 Ω for Models HTY78X3D series, HY78X3D series				
Time constant (at 2 m/s air velocity)	Temperature	Within 1 min. for Model TY78X3Z series		
		Within 4 min. for Models HTY78X3T series, HTY78X3D series, TY78X3D series		
Power supply	Humidity	1 min. or less (at constant temperature)		
		24 V AC +10/-15 % (50 Hz/60 Hz), 24 V DC ±10 % for Models HTY78X3T series, HY78X3T series		
Power consumption	24 V AC power	24 V DC ±10 % for Models HTY78X3D series, HY78X3D series, TY78X3D series		
		0.23 VA per 1 V DC to 5 V DC output: for Models HTY78X3T1X00, HY78X3T1000		
	24 V DC power	1.0 VA per 4 mA DC to 20 mA DC output for Models HTY78X3T4X00, HY78X3T4000		
		170 mW per 1 V DC to 5 V DC output for Models HTY78X3T1X00, HY78X3T1000		
Insulation resistance	Withstand voltage	800 mW 4 mA DC to 20 mA DC output for Models HTY78X3T4X00, HY78X3T4000		
		550 mW per output point 4 mA DC to 20 mA DC output for Models HTY78X3D series, HY78X3D series, TY78X3D series		
Min. 500 V DC, 20 MΩ (between the housing and terminals)		500 V AC applied for 1 min. with max. of 1 mA leakage current (between the housing and terminals)		
Environmental conditions		Rated operating condition	Limit operating conditions	Transport/storage conditions
For temperature measuring	Ambient temperature	-20 °C to 60 °C	-20 °C to 60 °C	-30 °C to 70 °C
	Ambient humidity	0 %RH to 100 %RH (non-condensing)	0 %RH to 100 %RH (non-condensing)	5 %RH to 95 %RH (non-condensing)
For humidity measuring	Ambient temperature	-5 °C to 55 °C	-20 °C to 60 °C	-30 °C to 70 °C
	Ambient humidity	0 %RH to 100 %RH (non-condensing)	0 %RH to 100 %RH (non-condensing)	5 %RH to 95 %RH (non-condensing)
Vibration	Vibration	4.9 m/s ² (10 Hz to 150 Hz)	4.9 m/s ² (10 Hz to 150 Hz)	9.8 m/s ² (10 Hz to 150 Hz) (in packaged state)
	Air velocity	—	0 m/s to 15 m/s	—

JIS: Japanese Industrial Standards

Item		Specification
Enclosure rating	Housing	IEC IP54 (dust-proof and splash-proof) * The specified water-proof gland and multi-core cables must be used. OR The specified cable conduit must be used. * Enclosure rating of the Probe of Model TY78X3Z series is IEC IP24.
Color	Housing	Gray
Materials	Housing	20 % GF containing Polycarbonate resin
	Filter cap	Modified PPE resin, gray
Weight		Approx. 240 g for Models HTY7803 series, HY7803 series, TY7803 series (long probe type)
		Approx. 210 g for Models HTY7813 series, HY7813 series, TY7813 series (short probe type)
Installation		onto an duct or AHU, in an instrument shelter (with the dedicated bracket)
Wiring length		Max. 100 m
Connection		Terminal block connection

AHU: Air handling unit

IEC: International Electrotechnical Commission

PPE: Polyphenylene ether

CE Marking Conformity

Models HTY78X3 series and HY78X3 series comply with the following Electromagnetic Compatibility (EMC).

EN61326-1 Class B, Table 1 (For use in a basic electromagnetic environment)

(EN61000-4-2, EN61000-4-3, EN61000-4-4, EN61000-4-5, EN61000-4-6)

Note:

Model TY78X3 series is "equipment which is inherently benign in terms of electromagnetic compatibility" and "is excluded from the scope of the EMC Directive."

Dimensions

Models HTY7803, TY7803, HY7803 series

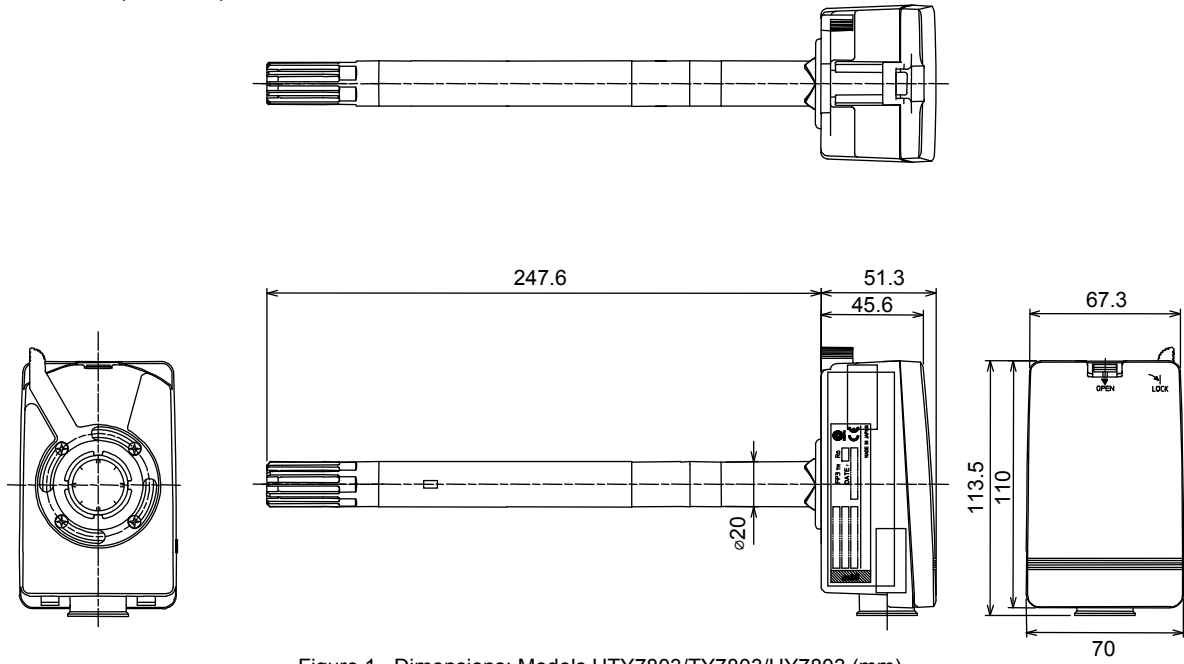

Figure 1. Dimensions: Models HTY7803/TY7803/HY7803 (mm)

Models HTY7813, TY7813, HY7813 series

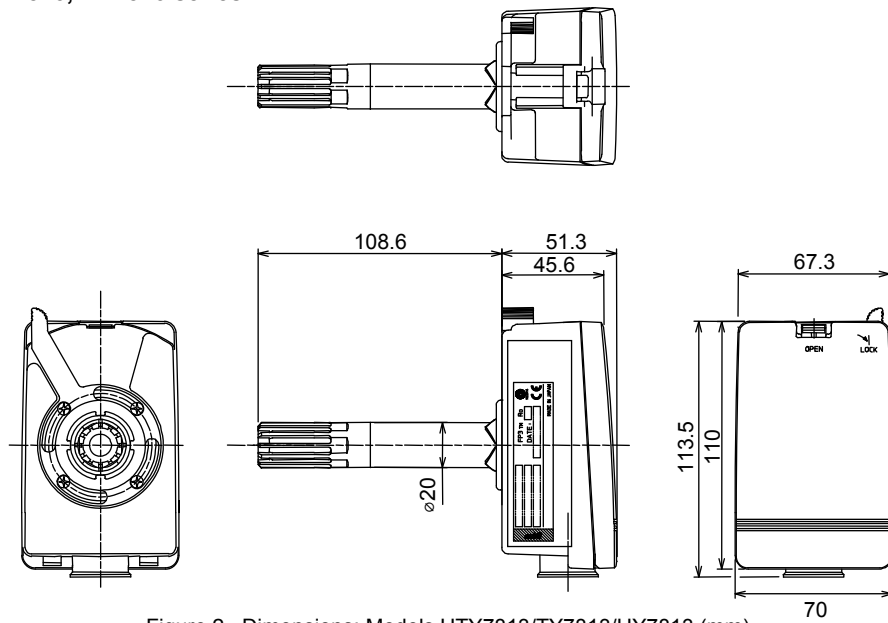

Figure 2. Dimensions: Models HTY7813/TY7813/HY7813 (mm)

Mounting bracket Part No. 83157235-001 (optional)

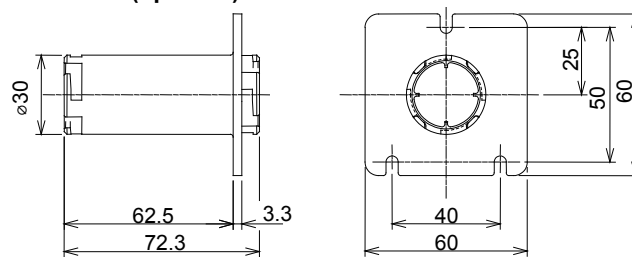

Figure 3. Dimensions: Part No. 83157235-001 (mm)

Installation

⚠ CAUTION	
!	Install the product in a location that satisfies the operating conditions (temperature, humidity, power, vibration, shock, mounting direction, atmospheric condition, etc.) as listed in the specifications and use the product within the operating ranges as listed in the specifications. Failure to do so might cause fire or device failure.
!	Installation and wiring must be performed by qualified personnel in accordance with all applicable safety standards.
⊘	Do not put load or weight on the product. Doing so might damage the product.

Installation requirements

- Select a location where the typical temperature and humidity of the process fluid can be measured at the specified air velocity.
- Make sure that the entire probe is immersed in the process fluid. Also, make sure that airflow passes perpendicular to the side of the probe.
- Leave adequate maintenance clearance in front of the housing cover.
- When installing in steam-heating AHU, make sure the probe is not directly exposed to the high-temperature steam. The high-temperature steam might exceed the probe limit operating condition.
AHU: Air handling unit
- Do not allow condensation especially when installing the probe pointing upward.
Condensation water that remains in the filter cap slits might cause measuring error till the filter cap becomes dried.

IMPORTANT:
When the duct sensor is faulty, reduced output may cause over-humidification. Provide safety measure on the controller in connection.

Installing Models HTY7803, TY7803, and HY7803 series (onto duct for general air conditioning)

- 1) Prepare the dedicated mounting bracket.
Attach the indicator label for mounting hole at the probe mounting position on a duct, and open a mounting hole.

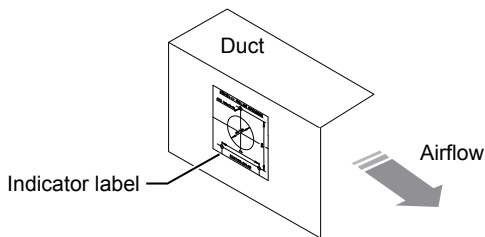

Figure 4. Indicator label on the duct

- 2) Mount the mounting bracket onto the duct so that the longer cylindrical part overhangs from the duct. Fix the mounting bracket with accessory M4 screws.

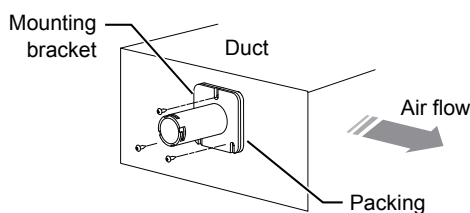

Figure 5. Mounting bracket on the duct

- 3) Wrap the duct with an insulating material.
(If the duct has been already wrapped with an insulation material, partially remove the material for mounting the bracket. Fill the clearance between the bracket and the duct with the insulating material after mounting the bracket.)

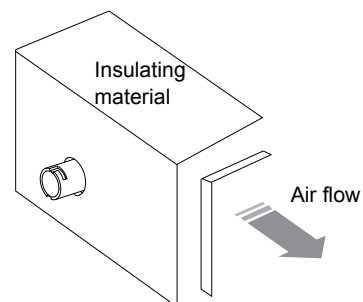

Figure 6. Duct and the mounting bracket wrapped with insulating material

- Release the stopper of the duct sensor by turning the stopper 45° (from "a" to "b" shown in Fig. 7). Then, insert the probe into the bracket and engage the tabs of the probe with the notches of the bracket.

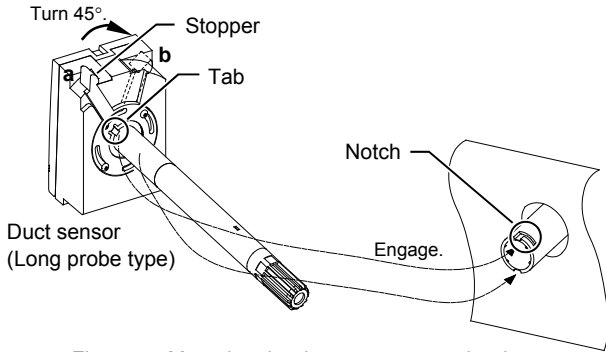

Figure 7. Mounting the duct sensor onto the duct (with the mounting bracket)

- Completely insert the probe, and lock the stopper of the duct sensor by turning the stopper 45° (from "b" to "a" shown in the figure below).

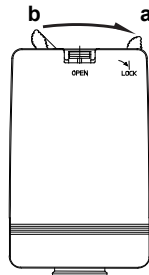

Figure 8. Locking the duct sensor stopper

Installing Models HTY7813, TY7813, HY7813 series (onto AHU, in instrument shelter, etc.)

- Prepare the dedicated mounting bracket. Attach the indicator label for mounting hole to the probe mounting surface, and open a mounting hole. (Skip this step for installing the duct sensor using the optional L-shape bracket.)

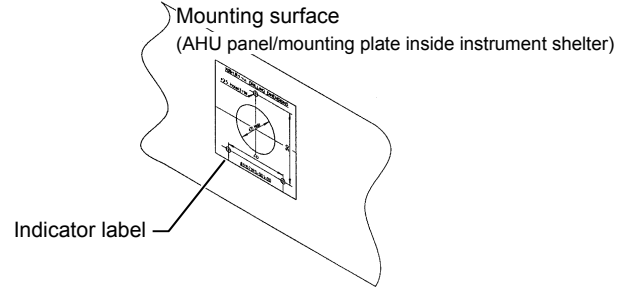

Figure 9. Indicator label on the AHU

- Mount the mounting bracket onto the duct so that the shorter cylindrical part overhangs from the mounting surface. Fasten the mounting bracket with accessory M4 screws.

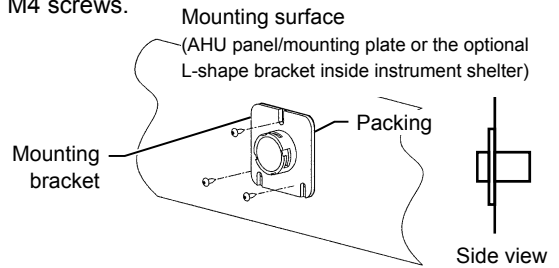

Figure 10. Mounting bracket on the panel

- Release the stopper of the duct sensor by turning the stopper 45° (from "a" to "b" shown in Fig. 7). Then, insert the probe into the bracket and engage the tabs of the probe with the notches of the bracket.

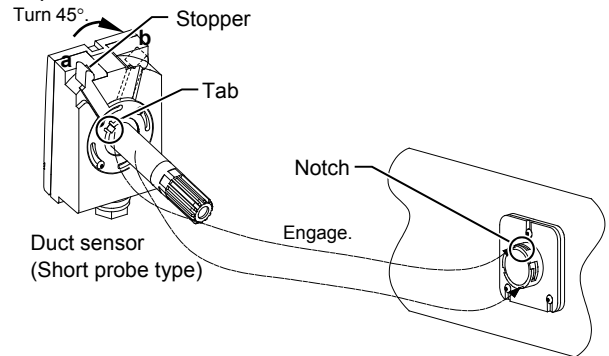

Figure 11. Mounting the duct sensor onto the AHU/L-shape bracket (with the mounting bracket)

- Completely insert the probe, and lock the stopper of the duct sensor by turning the stopper 45° (from "b" to "a" shown in the figure below).

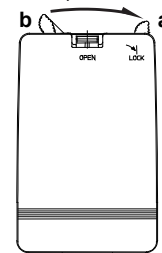











Figure 12. Locking the duct sensor stopper

Wiring

 WARNING	
	Before wiring and maintenance, be sure to turn off the power to the product. Failure to do so might cause electric shock.
	After wiring, be sure to reattach the terminal cover. Failure to do so might cause electric shock.

 CAUTION	
	Installation and wiring must be performed by qualified personnel in accordance with all applicable safety standards.
	All wiring must comply with applicable codes and ordinances.
	Be sure to provide a circuit breaker for the power to the product.
	To connect the wires to the screw terminals, use crimp terminal lugs with insulation. Failure to do so might cause fire or device failure due to short circuit.
	Firmly tighten the terminal screws. Insufficient tightening of the terminal screws might cause fire or overheating.
	Do not use unused/spare terminals on the product as relay terminals. Doing so might cause malfunction.

Precautions for wiring

- For power wiring and temperature/humidity output wiring, 1.25 mm² or 2 mm² shielded multi-core cables (JCS CVV-S cables) are recommended.
 - Be sure to ground the shielding on the controller side.
 - For Model HTY78X3D/HY78X3D/TY78X3D series, ground the shielding on the duct sensor side as well.
 - If dust-proof and splash-proof enclosure are not required, 1.25 mm² or 2 mm² JIS IV cable can be used for power wiring and temperature output wiring, and 1.25 mm² shielded cable can be used for humidity output wiring.
 - The maximum wiring length is 100 m.
- JCS: Japanese Electric Wire & Cable Makers' Association Standards
- Do not connect the cable for power supply to the temperature output terminals.
Doing so will generate smoke.
 - Always check wiring before supplying power.
Do not allow the 24 V AC transformer for the duct sensor to supply the power to any other devices.
 - Because the temperature sensor model with RTD (Pt1000) output is two-wire, the wire resistance will cause measuring error. For instance, 1.25 mm² size wire causes approx. 0.1 °C measuring error every 10 m. Correct the measuring error by setting the controller in connection.

Transformer for the duct humidity sensor / the duct temperature/humidity sensor

IMPORTANT:
 Use isolated transformer to supply 24 V AC power.
 Single duct humidity sensor or duct temperature/humidity sensor must be powered by a single 24 V AC transformer. If the multiple duct sensors or the duct sensor and other devices are powered by a single 24 V AC transformer, the common wiring will form a loop, and the duct sensor will get damaged.

24 V AC transformer:

Two duct humidity sensors (or duct temperature/humidity sensors) powered by a single transformer

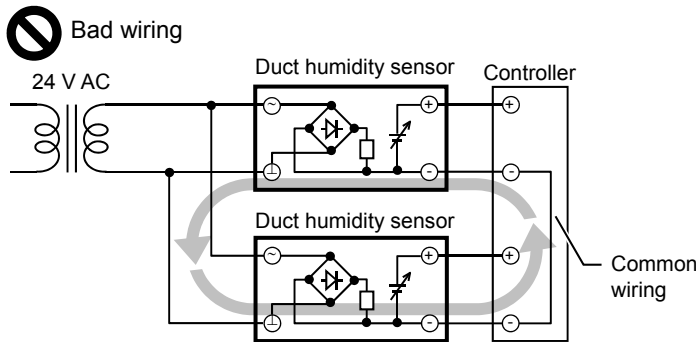

* Common wiring forms a loop.
 * The above figure shows a wiring example of Model HY78X3T.

Figure 13. Bad wiring example: Two duct humidity sensors powered by a single 24 V AC transformer

Two duct humidity sensors (or duct temperature/humidity sensors) separately powered by two transformers

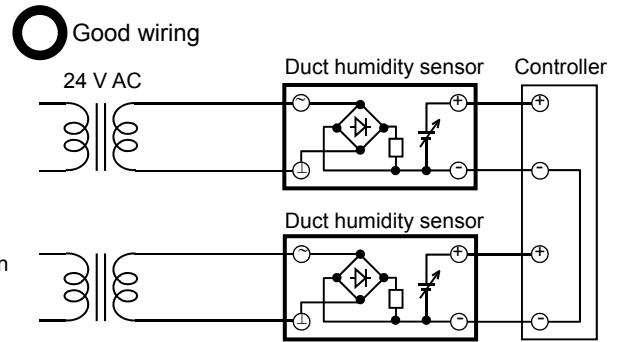

* Common wiring does not form a loop.
 * The above figure shows a wiring example of Model HY78X3T.

Figure 14. Good wiring example: Two duct humidity sensors separately powered by two 24 V AC transformers

24 V DC Transformer:

Two duct humidity sensors (or duct temperature/humidity sensors) (Model HTY78X3T/HY78X3T series) powered by a single transformer

For wiring of the duct temperature/humidity sensor / duct humidity sensor two-wire 4–20 mA type (Model HTY78X3D/HY78X3D series), refer to the wiring diagram Fig 26. Single duct sensor must be powered by single 24 V DC transformer.

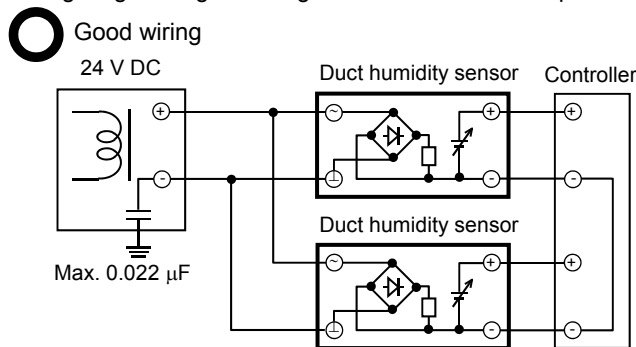

* Though common wiring forms a loop, common mode noise will affect a little.
 * For connecting terminals [-] and [E], use power with 0.022 µF or lower capacitive coupling.
 * The above figure shows wiring example of Model HY78X3T.

Figure 15. Good wiring example: Two duct humidity sensors powered by a single 24 V DC transformer

Notes for signal wiring

Induction current flowing from the duct humidity sensor or the duct temperature/humidity sensor to the controller input circuit and inadequate time constant of the controller might generate noise. To prevent noise, see the following.

- Use a controller with low pass filter (40 dB or higher removal ratio in normal mode) that receives signals from the duct humidity sensor or the duct temperature/humidity sensor.
- For insufficient removal ratio, provide an isolator on the controller input wiring.

Note:

No problem will occur for connecting the duct humidity sensor or duct temperature/humidity sensor to our controller.

IMPORTANT:

- Select the power supply for the duct sensor based on the allowable load (maximum current and power consumption)
- Do not use the transformer Model RYY792D (24 V DC power) for the duct temperature/humidity sensor / duct humidity sensor Model HTY78X3T/ HY78X3T with 4-20 mA output. Insufficient capacity will cause sensor malfunction.

Wiring procedure

- 1) Remove the front cover.

Detach the front cover while pressing the release tab of the case. (See "a" in Fig 16.) At this time, tilt the front cover more than 30°. (See "b" in Fig 16.) Then lift the front cover to remove. (See "c" in Fig 16.)

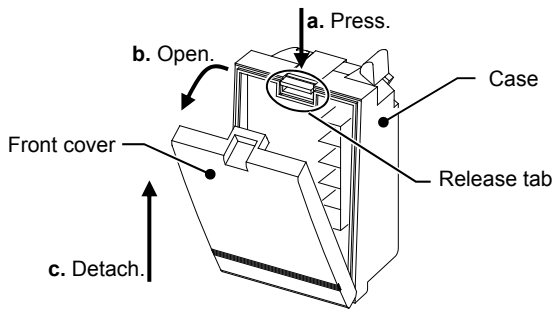

Figure 16. Detaching the front cover

- 2) Lead the cable through the wiring port.

Seal connector connection

Prepare the appropriate seal connector (optional) depending on the number of the conductors. Screw the threaded seal connector onto the wiring port and lead the cable into the duct sensor through the port.

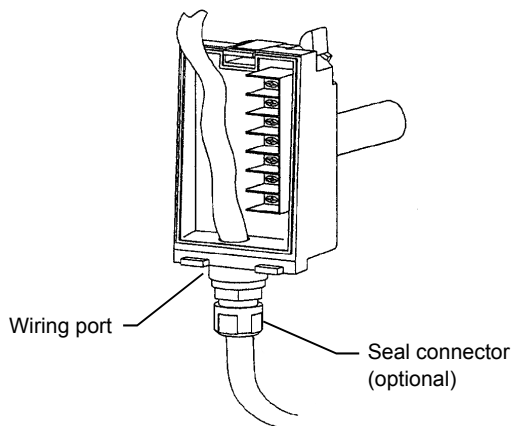

Figure 17. Seal connector connection

Conduit connection

Prepare the appropriate conduit mounting set (optional), depending on the number of the conductors. Temporarily screw the conduit connector and the attachment, and select an O-ring appropriate for the cable.

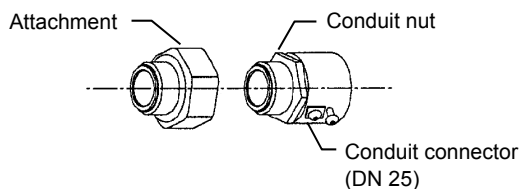

Figure 18. Conduit connection (1/2)

Lead the cable into the duct sensor through the port, and screw the attachment onto the wiring port. Position the conduit connector so that its conduit set screws can be easily tightened, and then tighten the conduit nut..

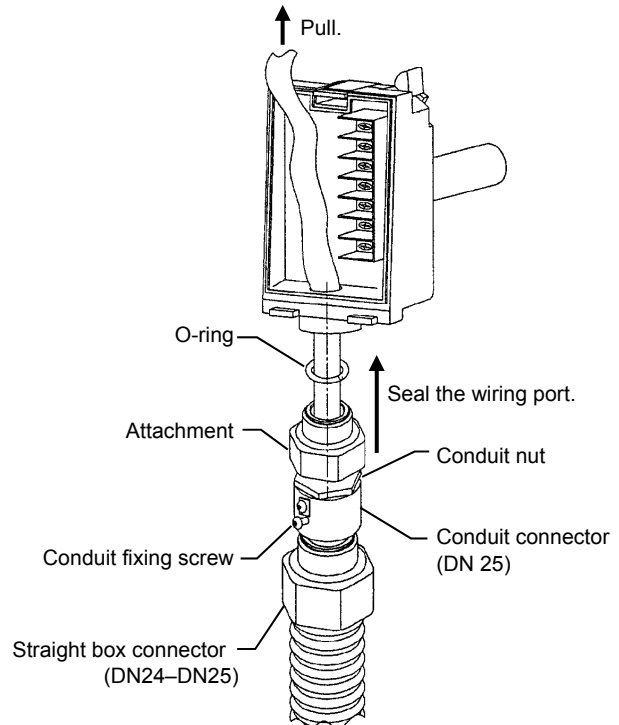

Figure 19. Conduit connection (2/2)

- 3) Connect the conductors.
Connect the conductors to the terminals, and attach the front cover to the case.

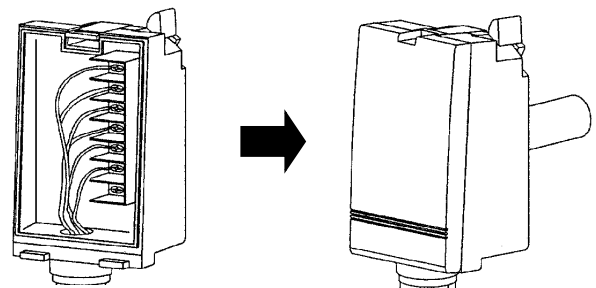

Figure 20. Attaching the front cover

- 4) Then, tighten the seal connector (for the duct sensor with the seal connector connection).

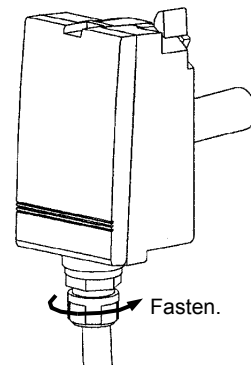

Figure 21. Tightening the seal connector

Wiring diagrams

Terminal wiring diagrams: Models HTY78X3T and HY78X3T series (24 V AC/DC power type)

Models HTY7803T1P00, HTY7803T4P00,
HTY7813T1P00, HTY7813T4P00

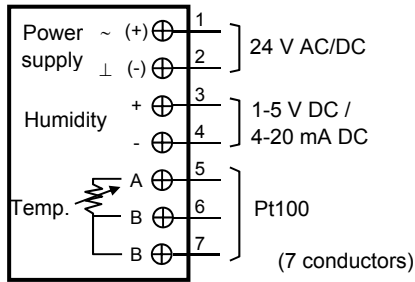

Figure 22. Terminal wiring: Duct temperature/humidity sensor with RTD (Pt100) output , 1-5 V/4-20mA humidity output, 24 V AC/DC power

Models HY7803T1000, HY7803T4000,
HY7813T1000, HY7813T4000

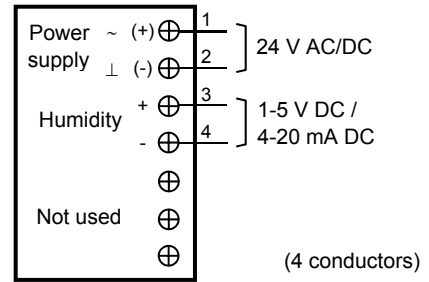

Figure 23. Terminal wiring: Duct humidity sensor with 1-5 V/4-20mA humidity output, 24 V AC/DC power

Terminal wiring diagrams: Model TY78X3Z series (No power type)

Models TY7803Z0P00, TY7813Z0P00

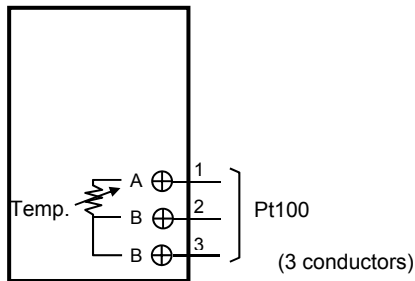

Figure 24. Terminal wiring: Duct temperature sensor with RTD (Pt100) output , no power

Models TY7803Z0K00, TY7813Z0K00

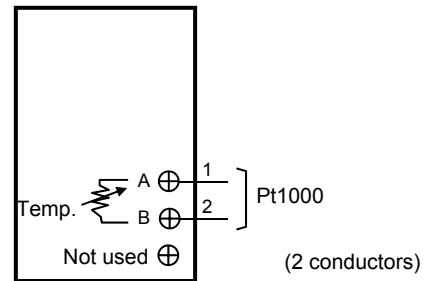

Figure 25. Terminal wiring: Duct temperature sensor with RTD (Pt1000) output , no power

Wiring diagrams: Models HTY78X3D, HY78X3D, and TY78X3D series with the controllers

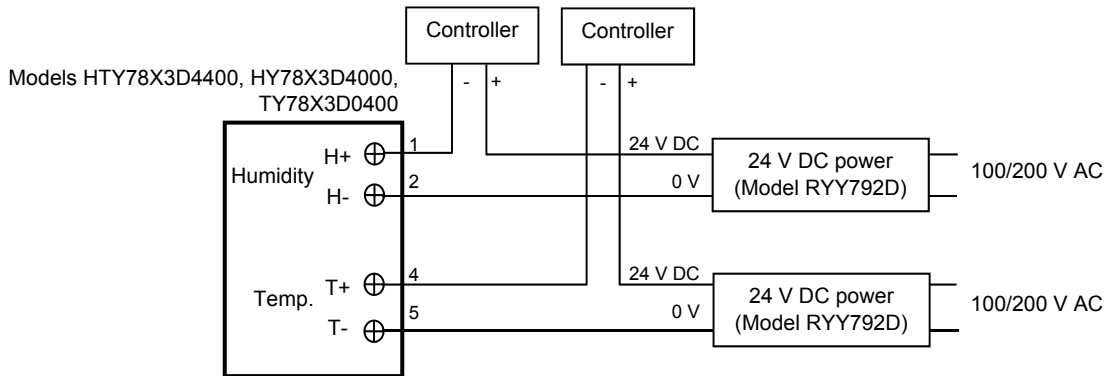

Figure 26. Wiring example: Duct temperature/humidity sensor, duct temperature sensor, duct humidity sensor with 4-20 mA temperature and/or humidity output, 24 V DC power

Inspection and Maintenance

Since Models HTY78X3, HY78X3, and TY78X3 series are factor-inspected and -calibrated for high accuracy, no field calibration is necessary when these products are installed. For inspection and maintenance, follow the maintenance instructions below:

Periodic inspection



Periodically inspect these products for its sensing accuracy. Set the period between inspections based on how much atmospheric dust and other contaminants are contained in the installation environment. Check that if the filter is clogged with dust and other contaminants, and clean the filter.

Troubleshoot

If any problem occurs during operation, refer to the following table for appropriate solutions.

Troubleshooting		
Problems	Check points	Solutions
<ul style="list-style-type: none"> • No output • Unstable output 	Loose wiring	Tighten the terminals.
	Disconnected wiring	Re-perform wiring.
	Power supply voltage	
	Duct sensor main unit damages	Replace the duct sensor.
Slow response to output	Moisture/condensation on the duct sensor	1. Detach the duct sensor from the bracket. 2. Remove the filter cap and the filter. 3. Air-dry the duct sensor in a clean air.
Error in output	Inappropriate installation location	Refer to Installation section and check if the installation location meets the requirements.
	Dust and contamination on the duct sensor main unit	Clean the filter.
		Replace the filter.
		Perform single-point calibration.
		Replace the duct sensor.

Filter replacement

 WARNING	
	Before wiring and maintenance, be sure to turn off the power to the product. Failure to do so might cause electric shock.

<p>IMPORTANT:</p> <p>Do not to touch the print board and other parts when these are not covered by the filter cap or the filter. Doing so might damage these parts.</p>
--

- 1) Prepare the new filter set (optional) for replacement. Loosen the old filter cap and filter and remove from the duct sensor.

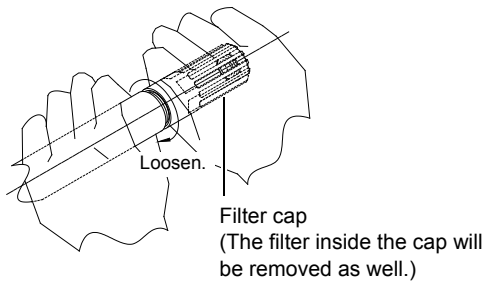

Figure 27. Filter cap removal

- 2) Before attaching the new filter, check that the rubber packing sealing the sensing element is not raised from the probe, as shown in Fig. 28.

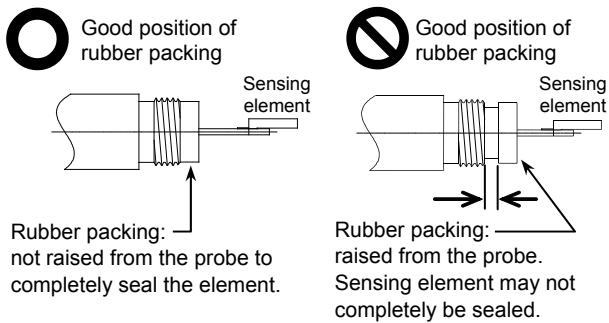

Figure 28. Rubber packing position

For rubber packing raised, press it using a slotted screwdriver as shown in Fig. 29.

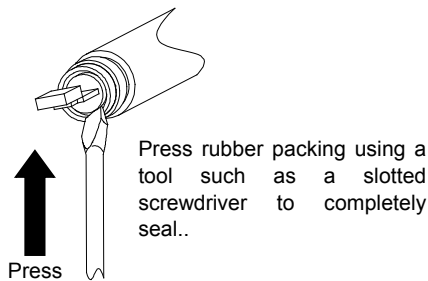

Figure 29. Pressing rubber packing

- 3) Attach the new filter and then the new filter cap to the duct sensor.

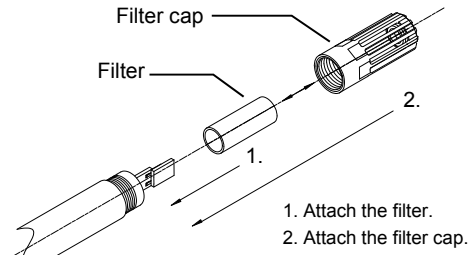

Figure 30. Attaching new filter and filter cap

- 4) Hand-tighten the filter cap.

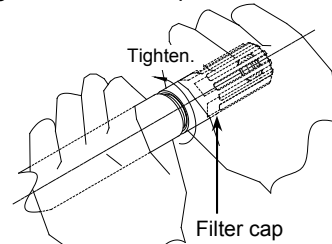

Figure 28. Tightening new filter cap

⚠ CAUTION	
!	Carefully press the rubber packing. Your fingers holding the tool might slip causing injury if you put too heavy force on the rubber packing.

IMPORTANT:	
Carefully use a slotted screwdriver or other tools while replacing the filter. Failure to do so might damage the electronic components and rubber packing.	

Humidity single-point calibration for Models HTY78X3 and HY78X3 series

When you find an error in the humidity sensing output, calibrate the duct temperature/humidity sensor or the duct humidity sensor with the adjustment knob located inside the duct sensor.

- The adjustment knob (VR1) is provided.
Turn clockwise to increase the output value and counterclockwise to decrease the output value.
- Use a reliable calibration instrument for the single-point calibration.
- Carefully handle the duct sensor and check the appropriate environment for the calibration.
- Calibrated digital multimeter is recommended to check output value.

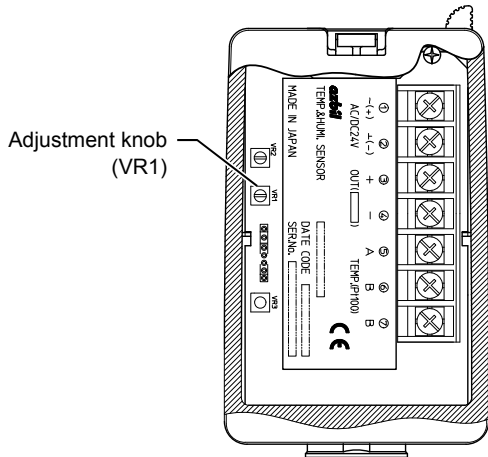

Figure 32. Adjustment knob (VR1) of Models HTY78X3T and HY78X3T series

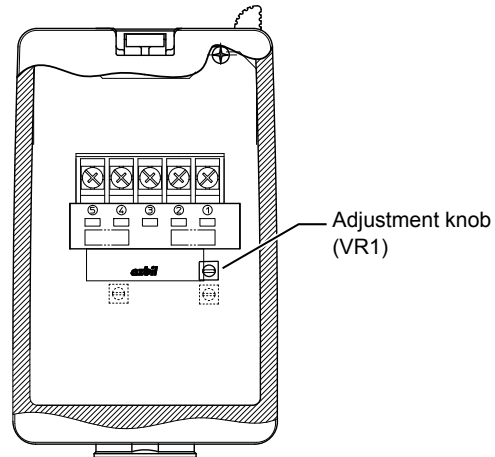

Figure 33. Adjustment knob (VR1) of Models HTY78X3D and HY78X3D series

Handling precautions

- After installation, leave the duct temperature/humidity sensor or duct humidity sensor for approx. 24 hours to adapt to ambient conditions (atmospheric environment).
- While calibrating the duct sensor or tuning the controller in connection, do not allow the heat generated from human body and/or appliances to affect the duct sensor or the controller.



Specifications are subject to change without notice.

Azbil Corporation
Building Systems Company

<http://www.azbil.com/>