



Control Valve Maintenance Support System PLUG-IN Valstaff

R43

Introduction

PLUG-IN Valstaff is a valve management system that detects problems with control valves and positioners at the earliest possible stage by monitoring diagnostic parameters and other information from the Smart Valve Positioner, thereby assisting to avoid accident/failure and helping to streamline maintenance tasks by clearly presenting the information required for decision-making on control valve maintenance. The PLUG-IN Valstaff monitors diagnostic information 24 hours a day, 365 days a year by communicating with Azbil Corporation's Smart Valve Positioner, which supports FOUNDATION™ fieldbus and HART® communication. Based on this diagnostic information, at the first sign of an abnormality, the system sends an alert in order to prompt action before the control valve can cause a problem, allowing continuously safe and secure plant operation. The PLUG-IN Valstaff also supports quick and accurate startup by automating positioner settings that adjust the control valve status, as well as automating step response tests. It also utilizes diagnostic information for routine maintenance, supporting the creation of an appropriate maintenance plan based on the degree of deterioration of control valves.

Function Overview

The PLUG-IN Valstaff, in combination with Azbil Corporation's Smart Valve Positioner, achieves its functions of CV diagnostics parameter monitoring, step response test, and auto-setup by means of integration with a device management system.

Online diagnosis & monitoring while the plant is operating

By collecting diagnostic parameter data from the Smart Valve Positioner and displaying it in a graph during plant operation, the progress of control valve deterioration and the occurrence of abnormalities can be estimated while the plant is operating. The PLUG-IN Valstaff collects data from the positioner and displays the following diagnostics graphs.

1. Total stroke

Displays a chronological graph of the total distance the valve stem has moved as a result of control of the valve travel.

2. Shut-off count

Counts the number of times the valve is completely closed and displays the total close counts in chronological order in a graph.

3. Cycle count

Counts the number of times the control valve motion was reversed and displays it in chronological order in a graph.

4. Travel histogram

Indicates the amount of time the control valve is in that position and the changes that occurred though time in a histogram.

5. Maximum travel speed

Constantly measures the operating speed of the control valve in both the opening and closing directions, calculates the maximum speed for each day, and then displays the maximum values for opening and closing directions over time.

6. Stick-slip diagnostics

Analyzes stick-slip occurrence trends.

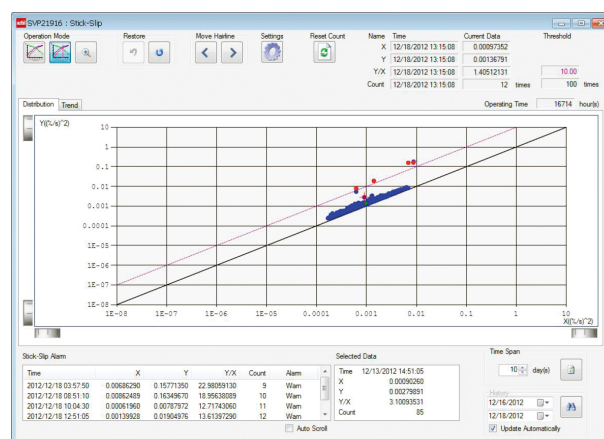

Figure 1. Stick-Slip Diagnostics Screen

7. Trend data

Displays the travel setting of any selected positioner, the actual travel of the control valve, deviation between travel the setting and actual valve travel, the EPM drive signal, and circuit board temperature. Data for up to one week can be displayed in graph form.

8. Po Validity/Max. Friction diagnostics

Displays the current relationship between output air pressure and valve travel in a graph together with the values obtained during auto-setup, which serve as a standard. Each day's output air pressure validity and maximum friction are indicated chronologically in the graph. (Only Smart Valve Positioner 700 series)

9. Air circuit diagnostics

Each day, the amount of shift from the normal values for the EPM drive signal and nozzle back pressure is calculated and displayed chronologically in a graph. (Only Smart Valve Positioner 700 series)

10. Supply Pressure

Displays the maximum value and minimum value of supply pressure per day in chronological order in a graph. (Only Smart Valve Positioner 700 series)

11. Zero Point Travel

Periodically updates the values for maximum and minimum travel when the valve is fully closed, and displays the maximums and minimums of each day in a chronological graph. (Only Smart Valve Positioner 700 series)

12. Temperature

Periodically updates the temperature measured by the temperature sensor on the electronics board of the positioner, and displays the maximum and minimum temperature of each day in chronological order in a graph. (Only Smart Valve Positioner 700 series)

13. A set of online diagnostic windows

Frequently used online diagnostic windows can be grouped to display a set of windows for individual control valves.

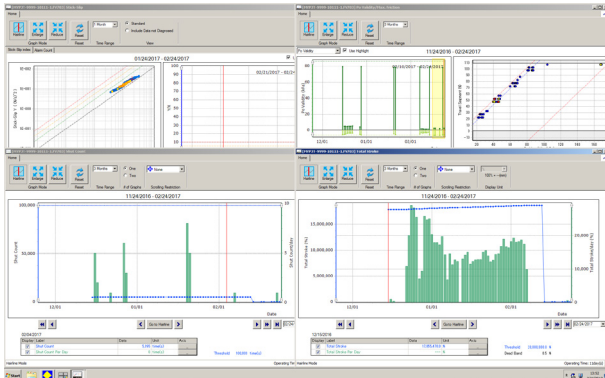

Figure 2. A set of control valve online diagnostic windows

14. Valve Condition Viewer

Displays accumulated online diagnostic results in a table. The results can be sorted and filtered by diagnostic items to show organized information about the current control valve condition.

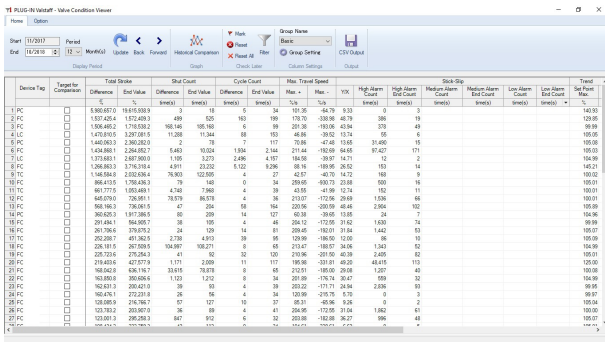

Figure 3. Valve Condition Viewer

By drawing monthly trend with accumulated online diagnostic result for multiple Control Valves, a CV which is different behavior compared to the other Valves can be visualized.

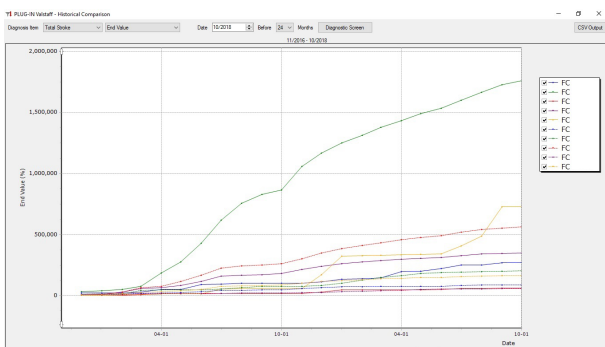

Figure 4. Monthly trend of Valve Condition Viewer

Offline Valve Test

A step response test or a valve signature test can be used to diagnose the condition of control valves when the plant is not operating.

1. Step Response Test

When the plant is not operating, the user can check the response of the control valve to changes by making step changes in the travel setting. The result is displayed in a graph that indicates slight changes that cannot be found by a visual check. The result is overlapped with past results for comparison, which is useful to find control valve deterioration and other problems.

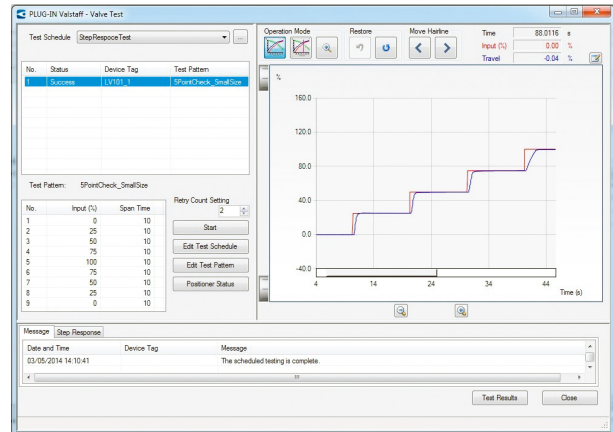

Figure 5. Step Response test Screen

Tests can be executed concurrently as well as consecutively for multiple valves, making use of a limited amount of time (Figure 6).

Control valve performance can be evaluated with quantitative dynamic characteristics data obtained from the test, such as time constants, delay time, and settling time, and by comparing the data with past results. The evaluation can be output as a report (Figure 7).

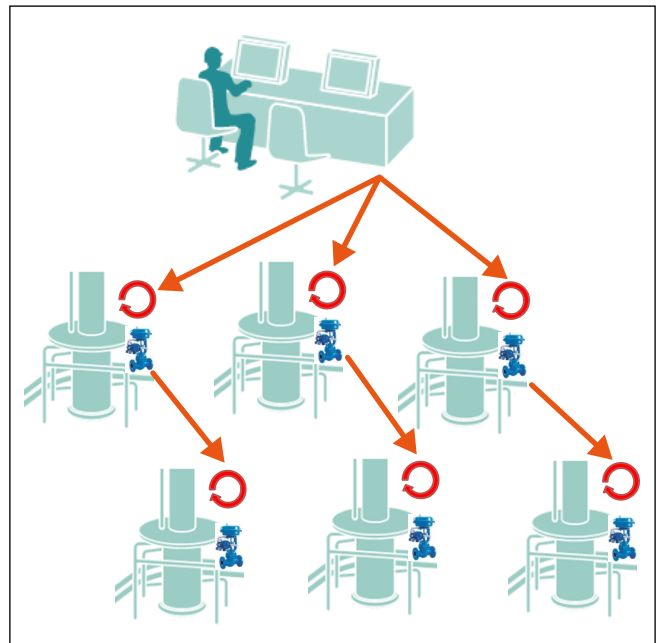

Figure 6. Diagram of step response testing

Note: In case of running this software on InnovativeField Organizer, this step response test can be executed for multiple Control valves simultaneously.

System Configuration

The PLUG-IN Valstaff works in conjunction with the InnovativeField Organizer™ (IFO) device management system made by Azbil Corporation or with the PRM® (Plant Resource Manager) made by Yokogawa Electric Corporation.

With Advanced-PS (TDCS3000)

By operating the PLUG-IN Valstaff on IFO, it is possible to manage control valves with a HART communication-compatible Smart Valve Positioner model AVP202/AVP302/SVX102/AVP307/AVP701/AVP702/AVP77_/AVP78_/AVP79_.

For details on system configuration, refer to the specification sheet for IFO (SS2-IFO430-0001).

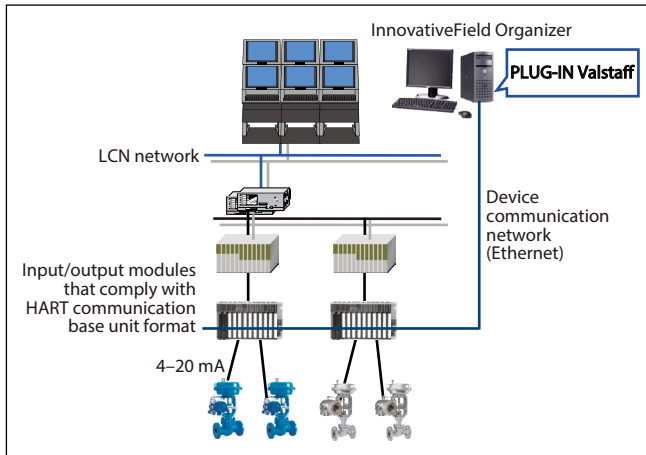

Figure 10. PLUG-IN Valstaff Configuration for Advanced-PS/TDCS3000

With Harmonas-DEO

By operating the PLUG-IN Valstaff on IFO, it is possible to manage control valves with a Smart Valve Positioner by using HART communication.

For details on system configuration, refer to the specification sheet for IFO (SS2-IFO430-0001).

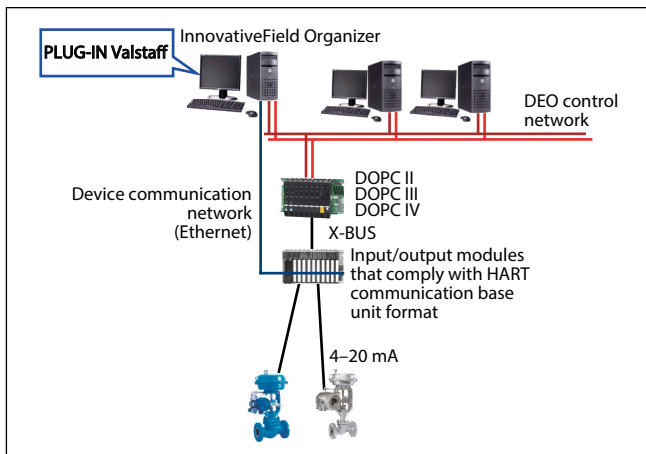

Figure 11. PLUG-IN Valstaff Configuration for Harmonas-DEO

IFO system configuration, which is independent of DCS model

The PLUG-IN Valstaff can be used in conjunction with IFO independent from DCS by using HNU (HART Network Unit). In this case, the PLUG-IN Valstaff can manage control valves with HART communication-compatible Smart Valve Positioner model AVP202/AVP302/SVX102/AVP307/AVP701/AVP702/AVP77_/AVP78_/AVP79_.

A HART modem or controller compatible with HART-IP can be used as an interface unit instead of HNU.

For details on system configuration, refer to the specification sheet for IFO (SS2-IFO430-0001).

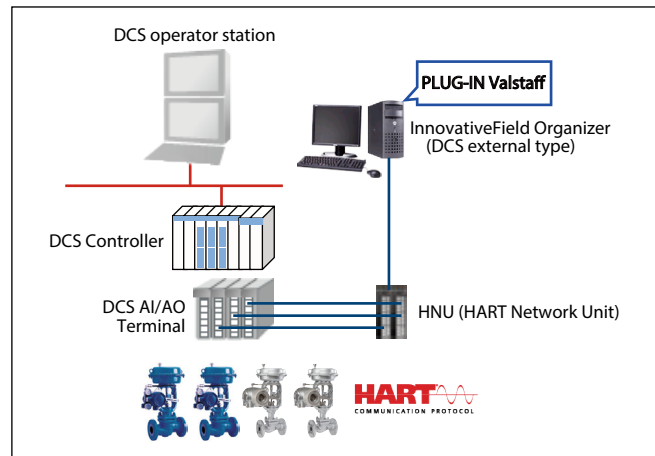

Figure 12. IFO system configuration, which is independent of DCS vendor and model

When Combined with Yokogawa Electric Corporation's PRM

The PLUG-IN Valstaff control valve maintenance support system can be used in conjunction with Yokogawa Electric Corporation's Plant Resource Manager (PRM).

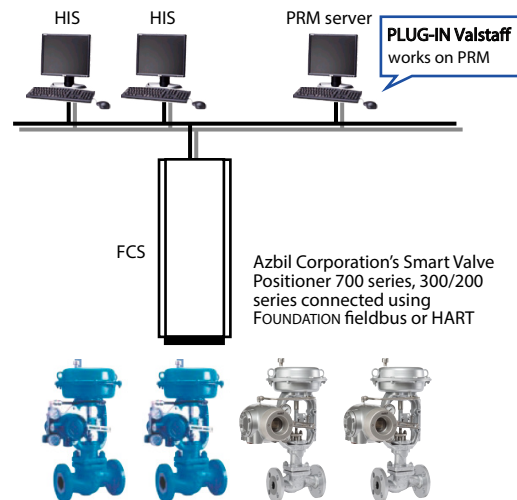

Figure 13. PLUG-IN Valstaff configuration on PRM Server

System Specifications

Maximum Number of Connected Smart Valve Positioners

The maximum number of positioners that can be managed by the PLUG-IN Valstaff is shown below. It is dependent on the communication protocol.

System	Communication protocol	Maximum number of managed units
Azbil Corporation's device management system IFO	HART	1000 *1
	FOUNDATION fieldbus	
Yokogawa Electric Corporation's PRM	HART	500 *1
	FOUNDATION fieldbus	

*1: The sum of FOUNDATION fieldbus devices and HART devices.

Data collection Specifications

Table 1. With IFO

Diagnostic parameter update interval	Stick-slip diagnostics:	400 s	
	Total stroke:	1 day *2	
	Maximum travel speed:	1 day *2	
	Total shut-off count:	1 day *2	
	Cycle count:	1 day *2	
	Po Validity/Max. Friction diagnostics:	1 day *2 *4	
	Air circuit diagnostics:	1 day *2 *4	
	Supply Pressure:	1 day *2 *4	
	Zero Point Travel:	1 day *2 *4	
	Travel histogram:	1 Month	
	Set Point (from DCS OP) and Valve opening:	Fastest 1 s	
	Output Air Pressure:	Fastest 1 s *2 *4	
	Deviation:	Fastest 1 s *2	
	Temperature:	Fastest 1 s *2	
Valve test*5 data sampling cycle	FOUNDATION fieldbus communication	Model AVP703	Fastest 50 ms
		Model AVP303	85 ms
	HART communication	Model AVP701/702/AVP77_/78_/79_	Fastest 50 ms
		Model AVP302/202	85 ms
Model AVP307	85 ms		
Device condition monitoring interval	Fastest 1 s *2		

Table 2. With PRM

Diagnostic parameter update interval	Stick-slip diagnostics:	400 s *1 *2	
	Total stroke:	1 day *2	
	Maximum travel speed:	1 day *2	
	Total shut-off count:	1 day *2	
	Cycle count:	1 day *2	
	Po Validity/Max. Friction diagnostics:	1 day *2 *4	
	Air circuit diagnostics:	1 day *2 *4	
	Supply Pressure:	1 day *2 *4	
	Zero Point Travel:	1 day *2 *4	
	Travel histogram:	1 month	
	Set Point (from DCS OP) and Valve opening:	Fastest 1 s *1 *2	
	Output Air Pressure:	Fastest 1 s *1 *2 *4	
	Deviation:	Fastest 1 s *1 *2	
	Temperature:	Fastest 1 s *1 *2	
Valve test*5 data sampling cycle	FOUNDATION fieldbus communication	Model AVP703	Fastest 50 ms
		Model AVP303	85 ms
	HART communication	Model AVP701/702/AVP77_/78_/79_	Fastest 50 ms
		Model AVP302/202	Fastest 5 s *3
Model AVP307	85 ms		
Device condition monitoring interval	300 s *2		

*1: In case of Valstaff running on PRM, the functions may not be available or specifications may be different depending on the performance of PRM Field Communication Server, HART communication performance every IO of CENTUM, and how to assign HART dynamic parameters by IOM Builder.

*2: Interval may require adjustment depending on the number of valve positioners connected.

*3: Depending on the communication performance, a simple test may be required instead of a step response test.

*4: Only Smart Valve Positioner 700 series

*5: Valve test refers to the step response test, valve signature test, partial stroke test, and full stroke test.

Table 3. Application Specifications

	Item	PLUG-IN Valstaff for IFO					PLUG-IN Valstaff for PRM				
		FF		HART			FF		HART		
		Model AVP303	Model AVP703	Model AVP302 AVP202	Model AVP701 AVP702	Model AVP307 *2	Model AVP303	Model AVP703	Model AVP302 AVP202	Model AVP701 AVP702	Model AVP307 *2
Positioner setup	Auto Setup	✓	✓	✓	✓	✓	✓	✓	✓	✓	✓
Offline Disgnostics in plant shutdown	Valve Signature *1		✓		✓			✓		✓	
	Step Response Test	✓	✓	✓	✓	✓	✓	✓		✓	✓
	Sequential automatic execution of Step Response Test to multiple CSv	✓	✓	✓	✓	✓	✓	✓		✓	✓
	Simultaneous execution of Step Response Test to multiple CVs	✓	✓	✓	✓	✓					
Online Diagnostics in plant operation	Total Stroke	✓	✓	✓	✓	✓	✓	✓	✓	✓	✓
	Total shut-off count	✓	✓	✓	✓	✓	✓	✓	✓	✓	✓
	Cycle Count	✓	✓	✓	✓	✓	✓	✓	✓	✓	✓
	Travel histogram	✓	✓	✓	✓	✓	✓	✓	✓	✓	✓
	Max Travel Speed	✓	✓	✓	✓	✓	✓	✓	✓	✓	✓
	Stick-slip diagnostics	✓	✓	✓	✓	✓	✓	✓	✓	✓	✓
	Zero point (Shut off) diagnostic	✓	✓	✓	✓	✓	✓	✓	✓	✓	✓
	Deviation diagnostics between Input and Travel	✓ *3	✓ *3	✓ *3	✓ *3	✓ *3	✓ *4	✓ *4	✓ *4	✓ *4	✓ *4
	Output air pressure validity *1		✓		✓			✓		✓	
	Max frictional force *1		✓		✓			✓		✓	
	Supply air pressure *1		✓		✓			✓		✓	
	Positioner air circuit abnormality *1		✓		✓			✓		✓	
	Trend data such as Input, Travel, Deviation, EPM drive signal	✓ *3	✓ *3	✓ *3	✓ *3	✓ *3	✓ *4	✓ *4	✓ *4	✓ *4	✓ *4
Summary Report generation for Online Diagnostics parameters	✓	✓	✓	✓	✓	✓	✓	✓	✓	✓	
Positioner Param. Backup	Param. Backup	✓	✓	✓	✓	✓	✓	✓	✓	✓	✓
	Param. Backup for many AVPs in bulk	✓	✓	✓	✓	✓	✓	✓	✓	✓	✓

*1: available for the model AVP701/AVP702/AVP703 only

*2: Require PLUG-IN Valstaff R43 or later in case of use in combination with the model AVP307.

*3: Data collection on best effort with fastest 1 second scan.

*4: With Exaopc communication, Data collection on best effort with fastest 1 second scan. (With communication via PRM, data sampling interval is 1 hour because of performance constraint)

Note: Require PLUG-IN Valstaff R43 or later to execute this function.

Target Smart Valve Positioner

Table 4. Smart Valve Positioner 300/200 series

Model number	Internal software version
Model AVP302	Ver. 3.D or later
Model AVP202	
Model AVP303	Ver. 2.1 or later
Model AVP203	
Model AVP307	Ver. 7.0 or later

Table 5. Smart Valve Positioner 700 series

Model number	Internal software version
Model AVP701/702/ AVP77_/78_/79_	Ver. 2.1 or later
Model AVP703	Ver. 2.5 or later

For detailed Smart Valve Positioner specifications, refer to the specification sheet for each product shown below.

Model AVP302:	SS2-AVP300-0100
Model AVP202:	SS2-AVP200-0100
Model SVX102:	SS2-SVX100-0100
Model AVP307:	SS2-AVP307-0100
Model AVP303/203:	SS2-AVP303-0100
Model AVP701/702:	SS2-AVP702-0100
Model AVP77_/78_/79_:	SS2-AVP772-0100
Model AVP703:	SS2-AVP703-0100

Operating Environment

The PLUG-IN Valstaff works on Azbil Corporation's IFO or Yokogawa Electric Corporation's PRM R3.10 or later.

Table 6. Computer platform

System/software package	Operating System
InnovativeField Organizer R43	Windows 7 Professional SP1 64-bit Windows 10 Pro (64-bit) *
RPM R3.10/ R3.11/R3.12/ R3.20/R3.30/ R3.31/ R4.01/R4.02	Windows Server 2008 Standard Edition Service Pack 2 (32-bit)
	Windows Server 2008 Standard Edition R2 Service Pack 1 (64-bit)
	Windows 7 Professional Edition Service Pack 1 (64-bit)
	Windows 10 Enterprise 2016 LTSB (64bit) Windows Server 2016 Standard Edition (64bit)

* For details, refer to the specification sheet for InnovativeField Organizer (R43).

License System

Table 7. PLUG-IN Valstaff base license

	Model number	Description
License for number of device connection	FNV-IFV4XE01	PLUG-IN Valstaff R4x License 16 TAG entry edition
	FNV-IFV4XE02	PLUG-IN Valstaff R4x License 25 TAG
	FNV-IFV4XE05	PLUG-IN Valstaff R4x License 50 TAG
	FNV-IFV4XE10	PLUG-IN Valstaff R4x License 100 TAG
	FNV-IFV4XE20	PLUG-IN Valstaff R4x License 200 TAG
	FNV-IFV4XE30	PLUG-IN Valstaff R4x License 300 TAG
	FNV-IFV4XE50	PLUG-IN Valstaff R4x License 500 TAG
	FNV-IFV4XE75	PLUG-IN Valstaff R4x License 750 TAG
	FNV-IFV4XEA0	PLUG-IN Valstaff R4x License 1000 TAG

Table 8. PLUG-IN Valstaff DMS (Device Management System) connection license

	Model number	Description
License for DMS connection	FNV-IFV4XE-A	PLUG-IN Valstaff R4x DMS connect License for IFO
	FNV-IFV4XE-B	PLUG-IN Valstaff R4x DMS connect License for PRM

Table 9. PLUG-IN Valstaff TAG extension license

After PLUG-IN Valstaff is installed, this license is used to increase the number of connected devices.

	Model number	Description
License for number of device extension	FNV-IFV4XEP1	PLUG-IN Valstaff R4x TAG extension license 16to25
	FNV-IFV4XEP2	PLUG-IN Valstaff R4x TAG extension license 25to50
	FNV-IFV4XEP3	PLUG-IN Valstaff R4x TAG extension license 50to100
	FNV-IFV4XEP4	PLUG-IN Valstaff R4x TAG extension license 100to200
	FNV-IFV4XEP5	PLUG-IN Valstaff R4x TAG extension license 200to300
	FNV-IFV4XEP6	PLUG-IN Valstaff R4x TAG extension license 300to500
	FNV-IFV4XEP7	PLUG-IN Valstaff R4x TAG extension license 500to750
	FNV-IFV4XEP8	PLUG-IN Valstaff R4x TAG extension license 750to1000

External Storage

Automatic backup and external storage is available for control valve diagnostic data collected by PLUG-IN Valstaff operating in IFO. Please use the external storage to prevent lack of data.

For automatic back-up, the user can use the following operability-confirmed external storage media.

- Tanberg Data Inc.
RDX QuikStor External USB Docking Station
Model: 8782
- Tanberg Data Inc.
RDX QuikStor Cartridge (Memory: 1 TB)
Model: 8586

Tanberg Data Inc. web site:

<http://www.tandbergdata.com/us/>

Notes



When using external storage for automatic back-up, keeping your PC safe is a necessity. However, please do not install anti-virus software on the PC used for IFO. Instead, do virus-checking remotely from another PC.

Also, if an external storage device whose operation we have not checked is used, Azbil Corporation cannot guarantee its operation or the integrity of the data. If the lack of a guarantee is acceptable and an external storage device which we have not checked is used, please use a device that meets the following conditions at a minimum.



- This device does not require special software (do not install software other than Azbil products on the PC used for IFO).
- This device does not incorporate a security function.

About icons for safety precautions









The safety precautions described in this document are indicated by the following icons.







	WARNING	Warnings are indicated when mishandling this product might result in death or serious injury.
	CAUTION	Cautions are indicated when mishandling this product might result in minor injury to the user, or only physical damage to the product.

■ Example

	The indicated action is prohibited.
	Be sure to follow the indicated instructions.

Safety precautions

 CAUTION	
	Before wiring, be sure to shut off the power to all devices that require power shutoff during wiring. Failure to do so may cause device failure.
	If an explosion-proof field device is used, never open its cover while it is running (while power is supplied). Doing so may result in an electric shock. For handling of this type of device, see the user's manual for the device.
	Do not touch electrically charged parts such as the power supply terminals. Doing so may result in an electric shock.
	Back up data and check for viruses regularly. Failure to do so may result in corrupted data or program malfunction.
	Do not install any anti-virus software into this PC. Check for viruses remotely from another PC.
	Do not connect the PC upon which the PLUG-IN Valstaff application software is to be installed to an external network such as the Internet or a corporate intranet. If the PC is infected by a virus, the collected data may be corrupted or a program may malfunction.
	Do not install any applications except those listed below on the PC upon which the PLUG-IN Valstaff application software is to be installed. <ul style="list-style-type: none"> • Device management system and associated software • PLUG-IN Valstaff application software • Driver for the USB hard disk drive used for data backup and loading (if necessary) Please keep in mind that Azbil Corporation's warranty does not cover any failures resulting from installation of any other applications.
	Before connecting the HART modem, inform operators in the control room that devices will be operate. Unexpected device behavior can injure workers.

 CAUTION	
	Before executing offline diagnostics, inform workers in the vicinity of control valves that the diagnostics will make the valves open and close regardless of signals from the controller. Unexpected valve opening or closing can injure workers.
	Before executing full stroke tests, inform workers in the vicinity of control valves that the tests will make the valves open and close regardless of signals from the controller. Unexpected valve opening or closing can injure workers.
	Before calibrating or adjusting the positioner, changing settings, or performing other related operations, check that the intended operation will not affect the operation of the plant and change the mode to "out of service."
	Before executing AutoSetup, inform workers in the vicinity of control valves that AutoSetup will open the valves from the fully closed position to the fully open position. Unexpected valve opening or closing can injure workers.
	When connecting the hard disk drive to another PC, perform a virus check before reconnecting it to the device management system.
	Before using PLUG-IN Valstaff online while devices are operating, please make sure that HART communication will not affect the host control system.

–Memo–

–Memo–

- Valstaff and InnovativeField Organizer are trademarks of Azbil Corporation.
- PRM® is a trademark of Yokogawa Electric Corporation in the USA and other countries.
- FOUNDATION is a trademark of FieldComm Group.
- HART® is a registered trademark of FieldComm Group.
- Windows 7, Windows 10 Pro, Windows Server 2008, and Windows Server 2016 are trademarks of Microsoft Corporation in the USA and other countries.
- Other product names, model nos., and company names may be trademarks of the respective company.

Please read "Terms and Conditions" from the following URL before ordering and use.

<https://www.azbil.com/products/factory/order.html>

Specifications are subject to change without notice.

The logo for Azbil Corporation, featuring the word "azbil" in a bold, lowercase, sans-serif font.

Azbil Corporation

Advanced Automation Company

1-12-2 Kawana, Fujisawa
Kanagawa 251-8522 Japan
URL: <https://www.azbil.com/>

1st edition: Apr. 2019