

Operator Panel

for Inflex™ AC / Inflex™ GC / Inflex™ GD

Model QY5100W0000 (Panel Mount Type)

Model RY5001Q0000 (Integral Type)

General

Operator Panel is a user terminal for data display and configuration, which can be connected to a remote unit: Inflex AC, Inflex GC, or Inflex GD. Two types of Operator Panel are available. Panel mount type (Model QY5100W0000) is mounted on the door of the control panel cabinet. Integral type (Model RY5001Q0000) is attached directly to the remote unit or to its I/O module to integrate with the remote unit.

The Operator Panel can display all the points that the remote unit has. Points to be modified (by changing their data configuration) or operated, such as parameters, AO (analog output), and DO (digital output), can be modified or operated through the Operator Panel.

By connecting the Operator Panel to a remote unit (Inflex AC, Inflex GC, or Inflex GD), the remote unit can be managed not only through client PC of our BMS (building management system), savic-net™ FX, but also through the Operator Panel at the installation site. This greatly improves the efficiency of the building management.

Additionally, the Operator Panel facilitates status indication of the points, and allows a remote unit to be easily used as standalone.

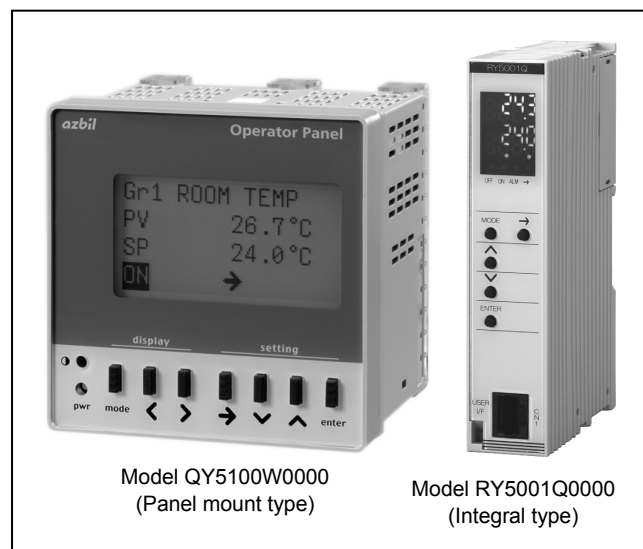

Model QY5100W0000
(Panel mount type)

Model RY5001Q0000
(Integral type)

Features

- Display of points:
All points of the remote unit can be managed through the Operator Panel.
The Operator Panel displays the points as follows:
 - Group-points mode
Points divided into up to 4 groups are displayed per group.
 - All-points mode
All the points of the remote unit are displayed.
 The points that can be modified or operated through the Operator Panel can be modified or operated in either mode. Additionally, one point selected among the ON/OFF points and the alarm points of the remote unit can be continuously displayed.
- Operation restriction:
ON/OFF operation and data configuration change through the Operator Panel can be restricted.
- Functions for a standalone remote unit:
When the remote unit connected to the Operator Panel is standalone, an operation schedule of the point specified to continuously display its status can be set through the Operator Panel. Additionally, the Operator Panel has a manual override function for AO and DO.
- LCD backlight and LED:
Model QY5100W0000 is equipped with an LCD backlight, and Model RY5001Q0000 is equipped with a 7 segment LED. Operator Panel thus displays the data and allows the operators to operate even in a dark place.
- CE Marking certified product:
Operator Panel (both panel mount type and integral type) conforms to all the applicable standards of CE Marking (Class A).







Safety Instructions

Please read instructions carefully and use the product as specified in this manual. Be sure to keep this manual near by for ready reference.













Usage Restrictions

This product is targeted for general air conditioning. Do not use this product in a situation where human life may be affected. If this product is used in a clean room or a place where reliability or control accuracy is particularly required, please contact Azbil Corporation's sales representative. Azbil Corporation will not bear any responsibility for the results produced by the operators.

 **WARNING**

-  • DANGER: To prevent the risk of severe or fatal electrical shock, always disconnect power source and product power supply before performing any wiring.
-  • Be sure to ground with 100 Ω or lower ground resistance. Improper grounding may cause electrical shock or equipment damages.
-  • Do not detach the terminal cover at any time except when wiring. After wiring, be sure to attach the terminal cover. Before attaching/detaching the terminal cover, make sure that the wires are not current-carrying to prevent electrical shock.
-  • Disconnect power before the product replacement to prevent electrical shock.
-  • Do not disassemble the product. Disassembly may result in electrical shock.

 **CAUTION**

-  • Installation and wiring must be performed by qualified personnel in accordance with all applicable safety standards.
-  • All wiring must comply with local codes of indoor wiring and electric installation rules.
-  • Use crimp terminal lugs with insulation for electric wires connected to the product screw terminals.
-  • Connect cables to the power source with terminals or the like for permanent connection.
-  • Make sure all the wires are tightly connected to prevent heat generation or equipment damages.
-  • Install a circuit breaker or circuit protector in the power supply circuit that supplies the power to the product.
-  • Lightning protection based on regional characteristics and building structure is needed in order to minimize lightning damages.
-  • If more than the rated power supply voltage is applied, product replacement is required for safety.
-  • Noise protection is necessary when the product is installed in a location close to many noise sources.
-  • Do not block the vent holes on the upper or lower part of the product to prevent equipment damages. Remove protective sheet after installation and wiring.
-  • This product must be operated under the operating conditions (power, temperature, humidity, vibration, shock, installation position, atmospheric condition, etc) specified in this manual to prevent equipment damages.
-  • Install this product in a location out of reach of unauthorized people.
(e.g. Panel mount type: door of the control panel cabinet / Integral type: inside of the control panel cabinet)
-  • Do not incinerate this product for waste disposal . Do not reuse all or part of this product, either.

Trademark information:

Inflex, savic-net, and Neopanel are trademarks of Azbil Corporation in Japan or in other countries.

Connection

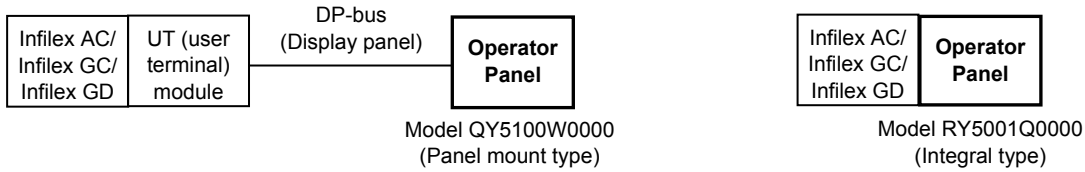
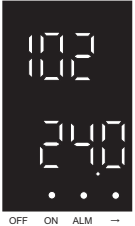
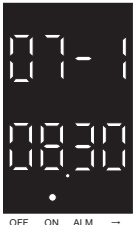

Figure 1. Connection examples

Functions

(1/2)

Function		Description
<p>Functions common to:</p> <ul style="list-style-type: none"> - Operator Panel connected with the system <p>and</p> <ul style="list-style-type: none"> - Operator Panel connected with the standalone remote unit. 	<p>Display and data configuration of the points</p> <p>Group-points mode (Display and data configuration)</p>	<p>Points classified by group are displayed. Up to 4 groups can be configured, and up to 16 points per group can be registered in any order. Two points (points 1 and 2) are displayed on the group top display, and the points are respectively displayed on the group scroll display.</p> <p>Points to be modified (by changing their data configuration) or operated, such as parameters, AO, and DO, can be modified or operated in the group-points mode.</p> <div style="display: flex; justify-content: space-around;"> <div style="text-align: center;"> <p>Group top display</p> <p>Model QY5100W0000 (Panel mount type)</p> </div> <div style="text-align: center;"> <p>Model RY5001Q0000 (Integral type)</p> </div> </div> <div style="display: flex; justify-content: space-around; margin-top: 20px;"> <div style="text-align: center;"> <p>Group scroll display</p> <p>Model QY5100W0000 (Panel mount type)</p> </div> <div style="text-align: center;"> <p>Model RY5001Q0000 (Integral type)</p> </div> </div>
	<p>All-points mode (Display and data configuration)</p>	<p>All points of the remote unit (max. 99 points) are displayed. The points are respectively displayed.</p> <p>Points to be modified (by changing their data configuration) or operated, such as parameters, AO, and DO, can be modified or operated in the all-points mode.</p> <div style="display: flex; justify-content: space-around;"> <div style="text-align: center;"> <p>Model QY5100W0000 (Panel mount type)</p> </div> <div style="text-align: center;"> <p>Model RY5001Q0000 (Integral type)</p> </div> </div>

Function		Description
<p>Functions common to:</p> <ul style="list-style-type: none"> - Operator Panel connected with the system <p>and</p> <ul style="list-style-type: none"> - Operator Panel connected with the standalone remote unit. 	<p>Display and data configuration of the points</p> <p>Group-points mode All-points mode (Display of: - operating status - alarm status)</p>	<p>One point among the ON/OFF and alarm points is specified to continuously display its status on the bottom line of the screen.</p> <div style="display: flex; justify-content: space-around; align-items: center;"> <div style="border: 1px solid black; padding: 5px; text-align: center;"> <p>Gr1 ROOM TEMP 02 SP 24.0 °C ON ALM →</p> <p>Model QY5100W0000 (Panel mount type)</p> </div> <div style="text-align: center;">  <p>Model RY5001Q0000 (Integral type)</p> </div> </div> <p>The above illustration shows that a point with ON/OFF and alarm status is specified and continuously displayed, indicating the operating status 'ON' and the alarm status 'reported.' When the operating status is 'OFF' and the alarm status is 'not reported,'</p> <ul style="list-style-type: none"> - Model QY5100W0000: [ON] or [ALM] is not displayed. - Model RY5001Q0000: Green dot above [OFF] is on and the green dot above [ALM] is off.
	<p>Available only for Model QY5100W0000</p> <p>Display of:</p> <ul style="list-style-type: none"> - Group name - Point abbreviated name - Engineering unit 	<p>Group names, abbreviated point names, and engineering unit are displayed.</p> <p>Note that an abbreviated point name is displayed using up to 4 alphanumeric characters, and a group name is displayed using up to 12 alphanumeric characters.</p>
	<p>Operation restriction</p>	<p>Operation and data configuration functions can be restricted to prevent careless configuration change or undesirable ON/OFF operation.</p>
<p>Functions of Operator Panel connected with the standalone remote unit</p>	<p>Schedule display*</p>	<p>Operation schedules for current day and the following day are displayed.</p> <div style="display: flex; justify-content: space-around; align-items: center;"> <div style="border: 1px solid black; padding: 5px; text-align: center;"> <p><SCHEDULE CHK> 07-1 8:30 ON</p> <p>Model QY5100W0000 (Panel mount type)</p> </div> <div style="text-align: center;">  <p>Model RY5001Q0000 (Integral type)</p> </div> </div>
	<p>Schedule setting*</p> <p>Operation schedule</p>	<p>The operation schedule can be set through the Operator Panel when it is connected to the standalone remote unit. Up to 8 schedules per day can be set and displayed for 8 days of the week (Monday through Sunday and one holiday).</p>
	<p>Holiday schedule</p>	<p>Dates for the holiday operation schedule can be set and displayed.</p>
	<p>Current date and time setting</p>	<p>Current date and time (year, month, day, hour, and minute) can be set.</p>
	<p>Manual override</p>	<p>For inspection and maintenance, manual operation and setting can be set to override the output signals from the remote unit.</p>

*Note:

Schedule display and setting functions are applicable only to the ON/OFF point specified to continuously display its status. If an alarm point is specified, the schedule display and setting function is not applicable.

Points to be continuously displayed on the screen (point types with their operating/alarm status)

Point type	Operating status	Alarm status
SAP (Status Alarm Point)	✓	✓
CAP (Command with Status Alarm Point)	✓*2	✓
SOP*1 (Status Only Point)	✓	
COP (Command Only Point)	✓	
CCP (Command with COS (Change of Status) Point)	✓*2	
AOP (Alarm Only Point)		✓

Notes:

*1 Status Only Point, which does not have any command, can be specified to continuously display on the screen.

*2 If CCP or CAP disagrees with its COS, its indicator [ON] or [OFF] flashes.

Specifications: Model QY5100W0000 (Panel Mount Type)**Main unit specifications**

Item		Specification	
Power supply	Model QY5100W0000	Rated voltage	100 V AC to 240 V AC, 50 Hz/60 Hz
		Allowable voltage range	85 V AC to 264 V AC
		Power consumption	8 VA
Environmental conditions	Rated operating conditions	Ambient temperature	0 °C to 50 °C
		Ambient humidity	10 %RH to 85 % RH (Non-condensing)
		Altitude	2000 m or lower
		Vibration	5.9 m/s ² or less (at 10 Hz to 150 Hz)
	Transport and storage conditions	Ambient temperature	-20 °C to 60 °C
		Ambient humidity	5 %RH to 85 % RH (Non-condensing)
Vibration (for storage)	Vibration (for storage)	5.9 m/s ² or less (at 10 Hz to 150 Hz)	
	Vibration (for transport)	9.8 m/s ² or less (at 10 Hz to 150 Hz)	
Status indication	LED (Green)	Power	ON: Power ON, OFF: Power OFF
Communication	DP-bus	Transmission system	RS-485
		Transmission speed	4800 bps
		Transmission distance	10 m
		Number of remote units to be connected	1
Display	LCD	Resolution	128 × 64 (dots)
		Gradation	2 tones: black and white
		Backlight	LED backlight
		Contrast adjustment	Trimmer
Input	Key	Material	Silicon rubber
		Key names	[mode], [<], [>], [←], [↵], [√], [enter]
Weight		400 g	
Material / color		Modified PPE / light gray	
Terminal connection	Power		M3 screw
	Communication (DP-bus)		M3 screw (Modular connection*) * Modular adaptor is pre-connected to the M3 screw terminals.

Wiring specifications

Item	Wiring	Wiring length	Condition
Power supply	JIS* IV 2.0 mm ² or JIS CVV 2.0 mm ² or greater	—	—
Ground	JIS IV 2.0 mm ² or JIS CVV 2.0 mm ² or greater	—	Ground resistance: 100 Ω or lower
DP-bus	Model DY7210 Connector cable, Model DY7220 Short connector cable, or Cable compliant to EIA/TIA-568 Category 5 or above	10 m	—

*JIS: Japanese Industrial Standards

Model Numbers: Model QY5100W0000 (Panel Mount Type)

Base model number	Power	—	Description
QY5100			Operator Panel for Inflex AC / Inflex GC / Inflex GD Panel mount type (Mounted on the door of the control panel cabinet.)
	W		100 V AC to 240 V AC
		0000	—

Note:

Operation manual for Model QY5100W0000 (AB-6547) is available. When you order the product, request the manual if necessary.

Specifications: Model RY5001Q0000 (Integral Type)

Main unit specifications

Item		Specification	
Environmental conditions	Rated operating conditions	Ambient temperature	0 °C to 50 °C
		Ambient humidity	10 %RH to 90 %RH (Non-condensing)
		Altitude	2000 m or lower
		Vibration	When assembled with Infilex AC: 5.9 m/s ² or less at 10 Hz to 150 Hz When assembled with Infilex GC/Infilex GD: 3.2 m/s ² or less at 10 Hz to 150 Hz
	Transport and storage conditions	Ambient temperature	-20 °C to 60 °C
		Ambient humidity	5 %RH to 95 %RH (Non-condensing)
		Vibration (for storage)	When assembled with Infilex AC: 5.9 m/s ² or less at 10 Hz to 150 Hz When assembled with Infilex GC/Infilex GD: 3.2 m/s ² or less at 10 Hz to 150 Hz
		Vibration (for transport)	9.8 m/s ² or less at 10 Hz to 150 Hz
Display	LED	7 segment LED	4 digit × 2 lines (Upper line in green, lower line in red) Upper line: Point number is displayed. Lower line: Max. 6 digit number is displayed. (Upper 2 digits are displayed first, and lower 4 digits are displayed with [∧] key.) For the decimal number, max. 3 digits after the decimal point are displayed.
		Dot LED for status indication	[OFF], [ON], and [->] in green [ALM] in red.
Input	Key	Material	Silicon rubber
		Key names	[MODE], [∧], [∨], [ENTER], [->]
Weight		170 g	
Material / color		Modified PPE / light gray	

Wiring specifications

Item	Wiring	Wiring length	Condition
Remote Controller bus	Model DY7210 Connector cable, Model DY7220 Short connector cable, or EIA/TIA-568 Category 3 or over	50 m	—

Model Numbers: Model RY5001Q0000 (Integral Type)

Base model number	—	—	Description
RY5001			Operator Panel for Infilex AC / Infilex GC / Infilex GD Integral type (Assembled with Infilex AC / Infilex GC / Infilex GD)
	Q		—
		0000	—

Note:

Operation manual for Model RY5001Q0000 (AB-6642) is available. When you order the product, request the manual if necessary.

CE Marking Conformity

This product must be installed in a panel cabinet. Besides, the product in the panel cabinet must be out of reach of unauthorized people who are not well-trained for electric facilities.

This product complies with the following Electromagnetic Compatibility (EMC) and the Low Voltage Directive (LVD).

EMC: EN61326-1 Class A, Table 2 (For use in an industrial electromagnetic environment)

LVD: EN61010-1 Overvoltage category II

Pollution degree 2

Dimensions: Model QY5100W0000 (Panel Mount Type)

<Main unit dimensions>

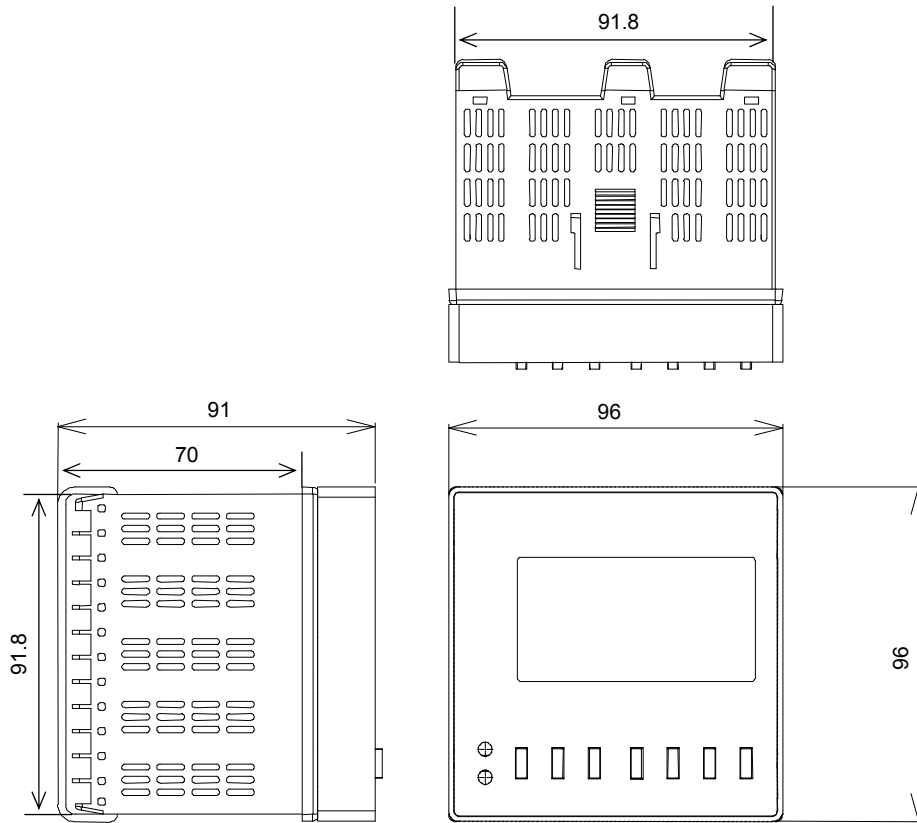

Figure 2. Main unit dimensions (mm): Model QY5100W0000

<Mounting panel cutout dimensions>

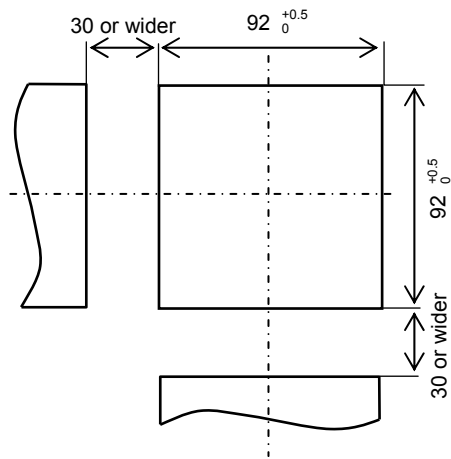

Figure 3. Mounting panel cutout dimensions (mm): Model QY5100W0000

Dimensions: Model RY5001Q0000 (Integral Type)

<Main unit dimensions>

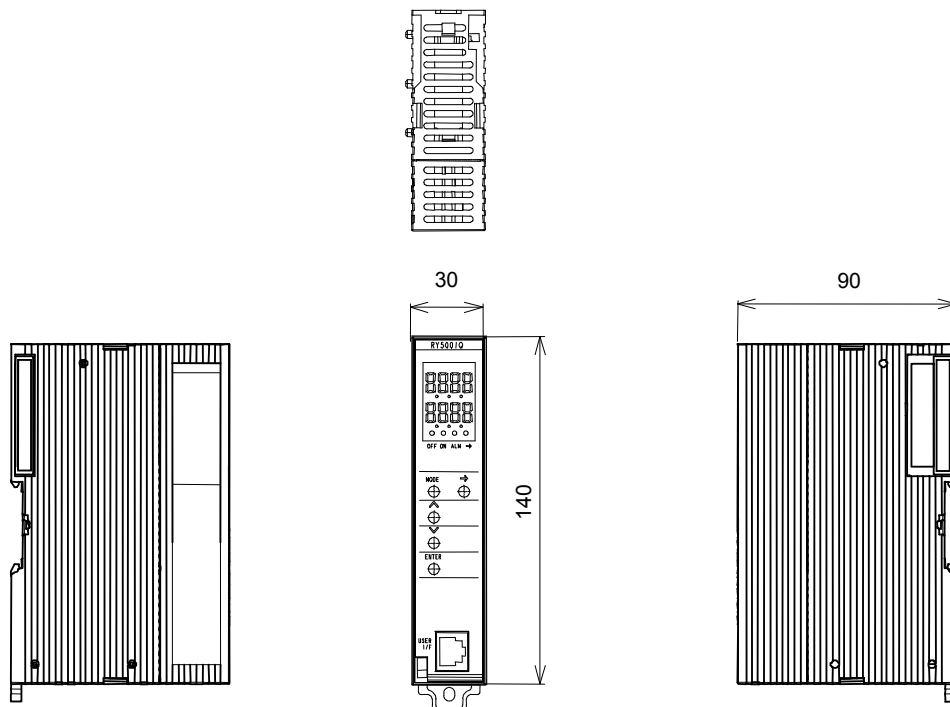
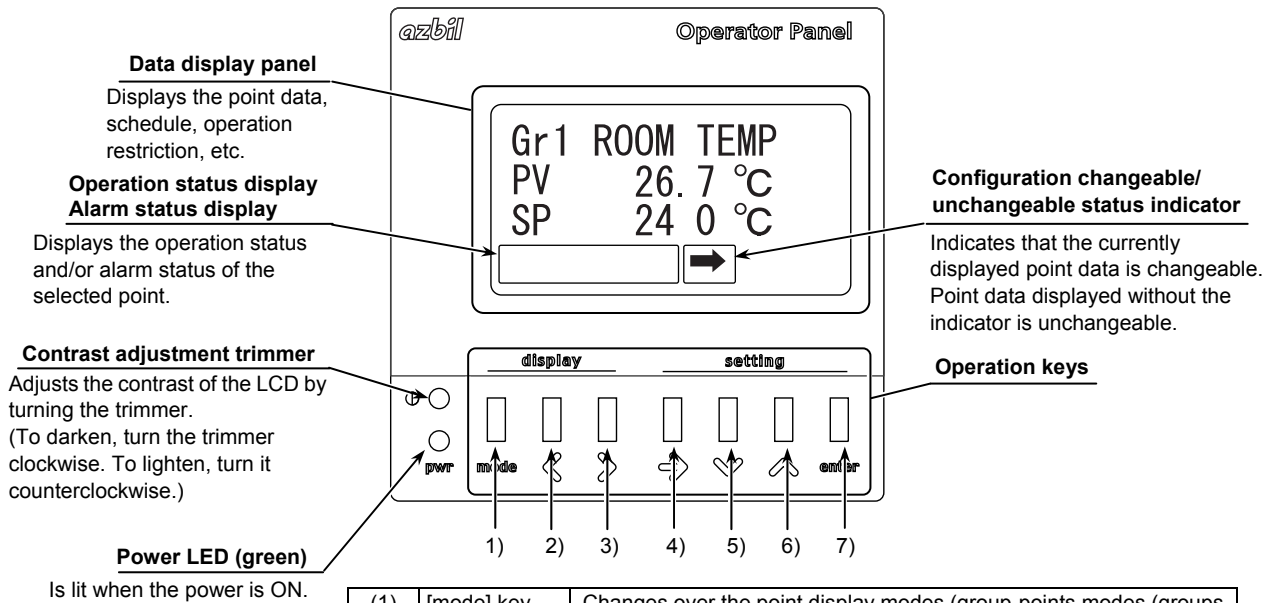

Figure 4. Main unit dimensions (mm): Model RY5001Q0000

Parts Identification: Model QY5100W0000 (Panel Mount Type)



(1)	[mode] key	Changes over the point display modes (group-points modes (groups 1 to 4) and all-points mode). When the Operator Panel is connected to a standalone remote unit, changes over the schedule display/setting, and current day/time setting modes.
(2)	[<] key	Changes to display the point data to the previous point data.
(3)	[>] key	Changes to display the point data to the next point data.
(4)	[→] key	For a configuration changeable point, switches the normal display (display only) to the configuration change display. In the configuration change display, selects a digit of the point data to change.
(5)	[v] key	For numeric data configuration, decreases the selected numeric digit. (The digit (9 to 0) descends one by one. After 0, the digit returns to 9.) For ON/OFF operation, switches ON to OFF. For positive/negative numeric data configuration, changes + to -.
(6)	[^] key	For numeric data configuration, increases the selected numeric digit. (The digit (0 to 9) ascends one by one. After 9, the digit returns to 0.) For ON/OFF operation, switches OFF to ON. For positive/negative numeric data configuration, changes - to +.
(7)	[enter] key	Fixes the configured point data. When the [enter] and [mode] keys are concurrently kept pressed for an extended period of time, a point display mode (or a mode unique to the Operator Panel connected to a standalone remote unit) is changed to the operation restriction mode.

Figure 5. Parts identification: Model QY5100W0000

Parts Identification: Model RY5001Q0000 (Integral Type)

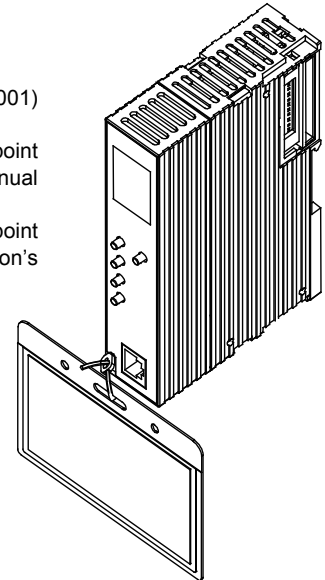
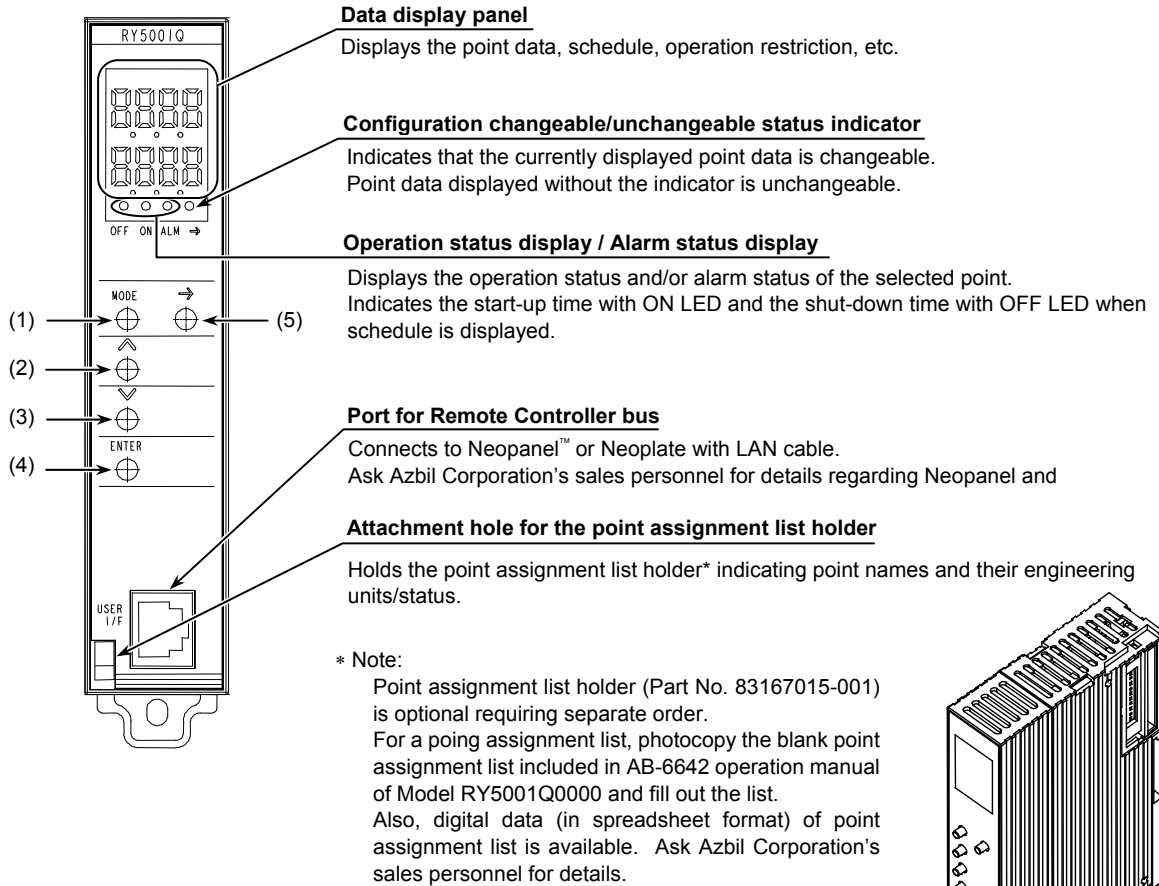

(1)	[MODE] key	Changes over the point display modes (group-points modes (groups 1 to 4) and all-points mode). When the Operator Panel is connected to a standalone remote unit, changes over the schedule display/setting, and current day/time setting modes.
(2)	[^] key	Changes to display the point data to the previous point data. For numeric data configuration, increases the selected numeric digit. (The digit (0 to 9) ascends one by one. After 9, the digit returns to 0.) For ON/OFF operation, switches OFF to ON. For positive/negative numeric data configuration, changes - to +.
(3)	[v] key	Changes to display the point data to the next point data. For numeric data configuration, decreases the selected numeric digit. (The digit (9 to 0) descends one by one. After 0, the digit returns to 9.) For ON/OFF operation, switches ON to OFF. For positive/negative numeric data configuration, changes + to -.
(4)	[ENTER] key	Fixes the configured point data. When the [ENTER] and [MODE] keys are concurrently kept pressed for an extended period of time, the normal display mode (or a mode unique to the Operator Panel connected to a standalone remote unit) is changed to the operation restriction mode.
(5)	[→] key	For a configuration changeable point, switches the normal display (display only) to the configuration change display. In the configuration change display, selects a digit of the point data to change.

Figure 6. Parts identification: Model RY5001Q0000

Installation

IMPORTANT:
 Do not install Operator Panel in a high temperature environment including locations exposed to heat radiation from heating/cooling system equipment or to the direct sunlight. Also, install in a location where the displaying contents can be seen clearly.

Model QY5100W0000 (panel mount type)

Precautions

- Use a minimum of 2 mm thick steel plate for the mounting panel. (e.g., door of a control panel cabinet where the Operator Panel is installed.)
- The allowable mounting angle is ranging from upright position to 10° tilted upwards or downwards.
- The angle of visibility is 80° (vertical and horizontal). Be sure to install Model QY5100W0000 in a location where its LCD is visible.
- Do not remove the protective sheet until the wiring work is completed.

Installation procedure

- 1) Insert Model QY5100W0000 from the front of the mounting panel.
- 2) From the rear of the mounting panel, attach the mounting brackets to Model QY5100W0000.
- 3) Keep the mounting brackets pushed until its claws are engaged with the grooves on Model QY5100W0000.
- 4) Tighten the screws of the mounting brackets attached to the top and the bottom of Model QY5100W0000.

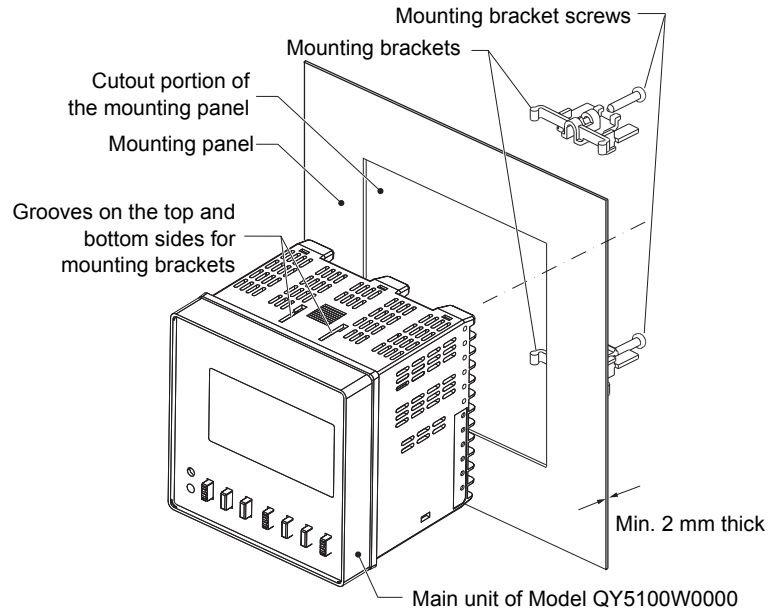

Figure 7. Model QY5100W0000 installation

IMPORTANT:
 Tighten the screws supplied with the mounting brackets until the mounting brackets get unshaken. Then, rotate (to tighten) the screws once to fix Model QY5100W0000 on the mounting panel.
 If the screws are tightened excessively, the case of Model QY5100W0000 may get deformed.

Model RY5001Q0000 (integral type)

Model RY5001Q0000, as well as the other modules (I/O and UT) connected to the Inflex GC/Inflex GD/Inflex AC basic unit, is mounted on a DIN rail. The connectable modules including Model RY5001Q0000 vary because the power supplied by the basic unit is limited. For details about installing Model RY5001Q0000, please refer to the respective Specifications/Instructions and Installation Manual.

Product	Document number	Document type
Inflex AC (for NC-bus)	AB-6438	Specifications/Instructions
Inflex AC (for LonTalk protocol)	AB-6584	Specifications/Instructions
Inflex AC (for IP)	AB-6489	Specifications/Instructions
Inflex GC (for NC-bus)	AB-6528	Specifications/Instructions
Inflex GC (for LonTalk protocol)	AB-6580	Specifications/Instructions
Inflex GC (for IP)	AB-6541	Specifications/Instructions
Inflex GD (for NC-bus)	AB-6529	Specifications/Instructions
Inflex GD (for LonTalk protocol)	AB-6581	Specifications/Instructions
Inflex GD (for IP)	AB-6542	Specifications/Instructions
Modules (I/O, UT, Operator Panel)	AB-6527	Specifications/Instructions
Inflex Series for LonTalk Protocol	AB-6651	Installation Manual

Wiring: Model QY5100W0000 (Panel Mount Type)**⚠ WARNING**

- Be sure to ground with 100 Ω or lower ground resistance. Improper grounding may cause electrical shock or equipment damages.

⚠ CAUTION

- Install a circuit breaker or circuit protector in the power supply circuit that supplies the power to the product.

IMPORTANT:

- Use max. $\phi 5.8$ mm (outer diameter) crimp terminal lugs.
- Multiple cables cannot be connected together to the power supply terminal. Avoid daisy-chain connection for the power supply terminals of Model QY5100W0000.

Connecting procedure

- 1) Connect the UT (user terminal) module and Model QY5100W0000 with the modular cable. Then, connect power supply.

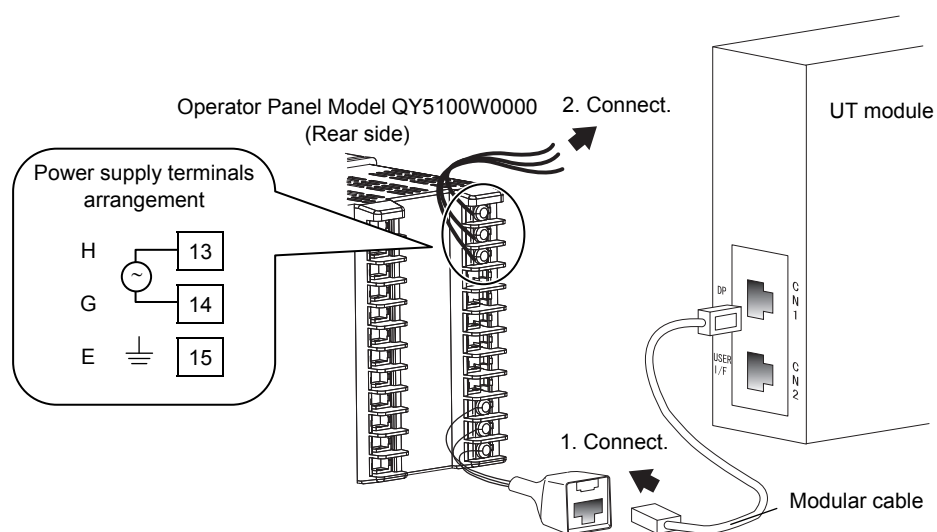

Figure 8. Connection to UT module

- 2) After the wiring installation is completed, peel off the protective sheet before supplying the power.

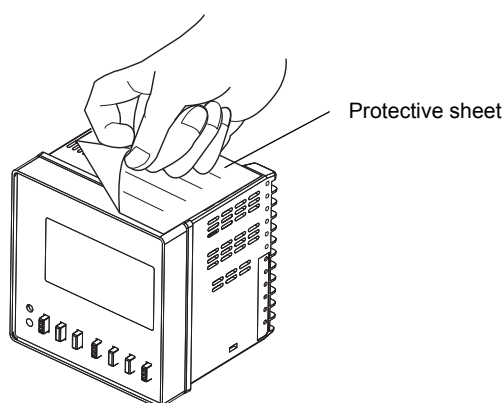

Figure 9. Protective sheet

Wiring: Model RY5001Q0000 (Integral Type)

Model RY5001Q0000 is directly attached to a Inflex GC/Inflex GD/Inflex AC basic unit or to its I/O module, etc. Wires connection therefore is not necessary unless Neopanel or Neoplate is connected to Model RY5001Q0000. (Neopanel/Neoplate is connected to Model RY5001Q0000 with LAN cable. A modular jack (port for Remote Controller bus) is provided on the front lower side of Model RY5001Q0000. (Refer to Fig. 6.)

Maintenance

Model QY5100W0000 (panel mount type)

Wipe off the LCD with dry soft cloth when needed. Any periodic part replacement is required. However, if the brightness or contrast of the LCD deteriorates, replace the LCD module.

LCD module: Part No. 83167012-001

If any part other than LCD module gets damaged (e.g. fuse disconnection), the whole unit requires to be replaced.

LCD module replacement

IMPORTANT:

- Only authorized service personnel are allowed to replace the LCD.
- Do not touch the power supply part during LCD replacement.
- Before replacing the LCD, be sure to turn off the power completely. Always replace the LCD with the power disconnected.
- Plastic screws are used to prevent static electricity. Be sure not to excessively tighten them so as not to break the screws, or be sure not to lose them. Metal screws cannot be substituted for the plastic screws.
- Be sure to discharge static electricity charged in your body (by touching the unpainted metal part of the panel, etc.) before and during the LCD module installation.

Required tools:

- Slotted screwdriver
- Phillips screwdriver

1) Remove the front panel using a slotted screwdriver.

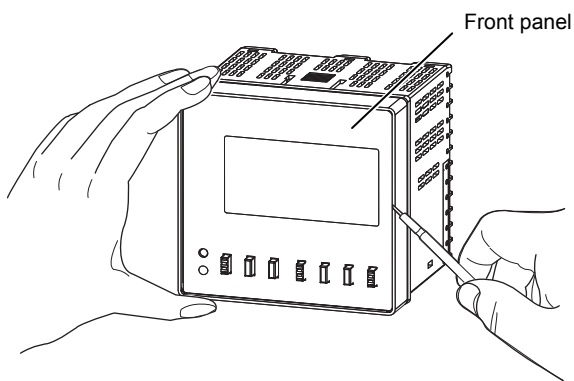

Figure 10. Front panel removal

2) Remove the transparent cover. Insert a slotted screwdriver in the clearance on the right, and pry the transparent cover.

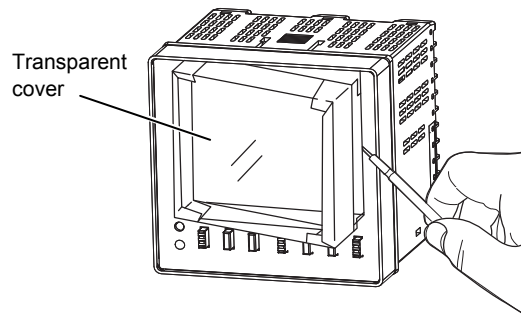

Figure 11. Transparent cover removal (1/2)
Hold the pried cover with fingers to pull it out.

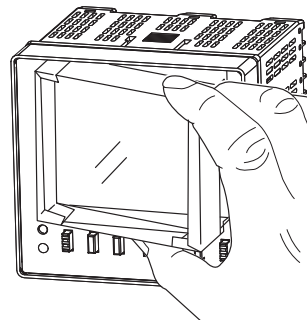

Figure 12. Transparent cover removal (2/2)

3) Remove the screw at the lower left of the LCD board.

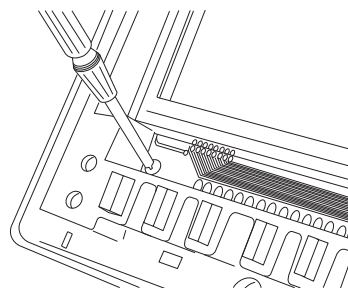

Figure 13. Screw removal

4) Remove the upper portion of the LCD module. At this time, note that the LCD module is connected to the LCD board with the connector.

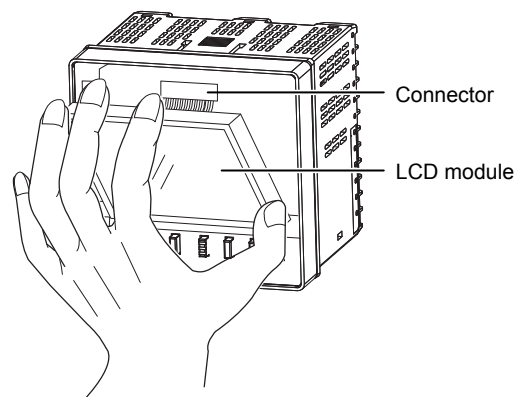

Figure 14. LCD module removal

- 5) Disconnect the connector to remove the LCD module.

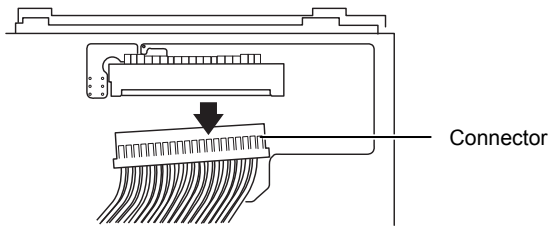

Figure 15. Connector disconnection

- 6) Mount a new LCD module.
 Connect the connector and hook the LCD module with the claws of the LCD board.
 Insert the screw into the hole located at the lower left of the LCD board, and then engage the LCD module with the boss at the lower right of the LCD board.

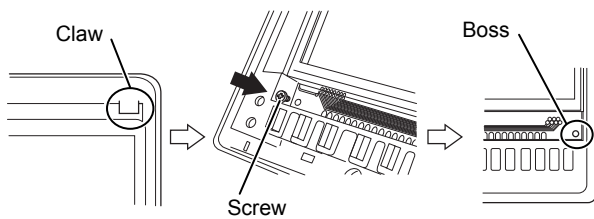

Figure 16. LCD module mounting

- 7) When the LCD module fits to the LCD board, tighten the screw at the lower left of the LCD board (in one location).

IMPORTANT:
 Screw-tightening torque is 0.07 N·m (0.7 kgf·cm).
 Larger torque than 0.07 N·m may break the screw.

- 8) Attach the transparent cover to the LCD module. (The wider side surface (to be inserted into the LCD module) needs to be located on the right.)
- 9) Mount the front panel.

Model RY5001Q0000 (integral type)

Any part replacement is not available for Model RY5001Q0000. If any part of Model RY5001Q0000 gets damaged, the whole unit requires to be replaced.

For details regarding the maintenance, ask Azbil Corporation's sales personnel.

azbil

Specifications are subject to change without notice.

Azbil Corporation
Building Systems Company

<http://www.azbil.com/>